



IRRIOT BSPB 1-128

User's Manual

—

Version 2.5

IRRIOT AB
P.O. Box 144
182 12 DANDERYD
SWEDEN
support@irriot.com

Table of Contents

Revision History	4
Basics of Operation	5
Fact Sheet	5
Wireless Irrigation Controller (Base Unit)	6
Main Features	6
Remote Terminal Unit (RTU)	7
Specifications	7
Cloud Based Control and Monitoring	8
Latency and Open-Ahead	8
Irrigation Rules	10
Switch Rules	11
Level Rules	11
Range Rules	13
Chained Valves (Master Valves)	14
Horizontal Chain	15
Vertical Chain (Master Valve)	15
Hybrid Chain	16
Effect of Delays	16
Water Metering	17
Common Topologies	18
Configure Water Meter	19
Measuring Flow	20
Control of External Equipment	22
Backup Power	23
Autonomous Base Unit	23
Firmware Upgrade	23
Usage	25
Main Screen, Navigation, LEDs	25
Main Screen	25
Navigation	27
Alarm LED	29
Sensor LED	29
Flow LED	30
Manual Operations	30
Programs	32
General	32

Start Times	33
Run Times	37
Weekdays	41
Pause	41
Continuous Mode	42
Interval Mode (every-N-days)	42
One-shot Mode	42
Seasonal adjust	42
Start Condition	43
Reset	44
Alarms	45
Wireless Stations (RTUs)	45
Pairing	46
Unpairing	47
Restarting RTU Remotely	47
Wireless Station Configuration	48
Sensor configuration	50
Valve configuration	51
Settings	51
Status	53
WiFi Status	53
Water Usage	54
On-Demand Irrigation	54
General	54
Sensor	55
State	55
Ports	55
Weekdays	56
Pause	56
Time	57
Extensions	57
Relay Port Configuration	58
Input Port Configuration	59
0...20mA and 4...20mA Configuration	60
Switch sensor input Configuration	60
Counter Input Configuration	60
Rules	61
Configuration	63
Set Date/Time	63
Advanced	64

Soft AP	64
Reset WiFi	66
Water Meters	66
Other options	68
System OFF/ON	68
Log	68
About	69
Appendixes	69
Appendix A: Alarms and Troubleshooting	69
Appendix B: Extension Boards	73
Extension board MPE6-4	73
Current Loop Sensor Wiring	74
Counter and Switch Sensor Wiring	75
12VDC Battery port	75
Bus connector	75
Slot selection Jumper	75
Extension board RE-8	76
12VDC Battery port	76
Bus connector	76
Output Ports	77
Slot selection Jumper	77
Appendix C: Winterization	78

Revision History

Rev	Date	By	Description
1.1	2020-03-04	Mikhail	Original version
2.4	2024-10-15	Mikhail	<ul style="list-style-type: none"> • Suspend/Resume program; • Alarm listing and alarm reset; • Open port swap display; • Resettable flow meter counters • Flow meter configuration
2.5	2024-11-26	Mikhail	<ul style="list-style-type: none"> • Real-time flow display; • Subsidiary RunTime support in the controller; • Multiple irrigation rules per RunTime in the controller.

Basics of Operation

Fact Sheet

IRRIOT implements the next generation of commercial irrigation solutions. IRRIOT platform enables efficient watering where originally it was not possible or very impractical. As an irrigation solution IRRIOT aims at reaching optimal soil conditions, by intelligently dimensioning the water supply to the intended zone.

An irrigation system controls electrically operated valves from the central computer, Irrigation Controller. The key difference of IRRIOT Wireless Irrigation Controller from the classical controller, is the use of wireless two-way communication to the valves/sensors. In practice it means IRRIOT introduces wireless valve that could be situated at any remote location (up to 3 km from the Irrigation Controller, depending on the landscape. Additionally, IRRIOT can remotely control pumps and other equipment.

The primary users of the IRRIOT solution are:

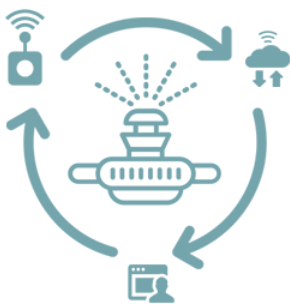

- Gardens and farms;
- Greenhouses;
- Rooftop gardens;
- Cemeteries;
- Sports Fields;
- Golf courses;
- Parks and public areas;
- Residential areas.

The solution consists of several parts - Wireless Irrigation Controller (Base Unit), Wireless Valve Control Station (Remote Node), Cloud Based Control and Monitoring.

Wireless Irrigation Controller (Base Unit)

Wireless Irrigation Controller, communicating with up to 32 Remote Nodes (RTU). The Base Unit is equipped with a display and a set of push buttons, which allows it to configure watering in various ways. The Base Unit is responsible for 24/7 execution of preconfigured watering schedules, soil state monitoring, events of failure, etc.

The Base Unit is an IoT Device connected to Microsoft Azure IoT Hub*.

Main Features

- Up to 34 sensors (e.g. Rain or Soil Moisture sensors). If the Base Unit is equipped with extension modules MPE6-4 additional 12 sensors can be wired directly to the Base Unit
- Up to 128 electromagnetic valves
- Up to 15 independent or parallel watering programs
- Up to 8 start times per program
- One shot, continuous and repetitive programs

*optional WiFi Module (dongle) required.

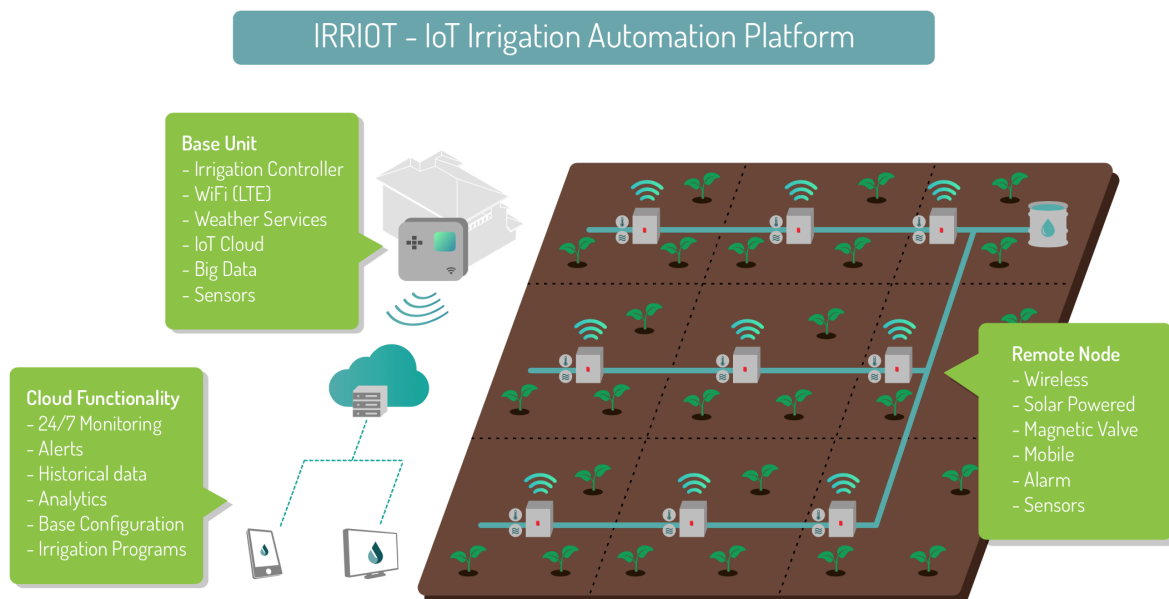

Remote Terminal Unit (RTU)



The **Remote Terminal Unit (RTU)** is maintenance free, solar powered, field unit, 2 valve Remote Unit operates up to 2 independent valves, 4 valve Remote Unit operates up to 4 independent valves, designed for outdoor use with multiple mounting options. The Remote Unit can also sample and relay the reading of one sensor, analog soil moisture sensor or any switch type sensor.

Specifications

Radio Technology	LoRa, ISM radio band (License Free)
External Connectors	2 x 2pin or 2 x 3pin, 1 x 6pin, 1 x MicroUSB (IP65)
Dimensions (without connectors)	W 91 x H 112 x D 78mm
Rechargeable Battery	Size 18650 Li-Ion (no replacement needed)
Antenna	Internal/External
Operating Temperature	-30C to +60C
Supported solenoids	DC Latching Solenoids (Hunter®, Toro®, Dorot®, Baccara®, etc.)
Supported sensors	Watermark 200SS Tensiometer Volumetric Soil moisture BGT Volumetric Soil moisture SM-150T Volumetric Soil moisture EC-5 EC (conductivity) Sensor, pH Sensor Water flow meter, Rain gauge Pressure gauge (0..20mA) Water level gauge (0..20mA) Air Humidity and temperature Sensor, or any switch type sensor
Mounting Options	Pole, Fence, Wall
Waterproof IP rating	IP65 Vented
Solar panel	Integrated solar cell

Cloud Based Control and Monitoring

Optionally, IRRIOT system can provide internet connectivity and remote system control. The Base Unit is an IoT device and it is connected to the Microsoft Azure cloud. The IRRIOT web and mobile app functionality includes:

- Monitoring of Alarms on the Base and Remote Unit levels;
- Monitoring of states of magnetic valves and sensors;
- Activation of magnetic valves manually, either immediately or delayed;
- Scheduled irrigation - configuration of programs, a sequence of zone activations;
- Sensor based On-Demand irrigation;
- Weather forecast;
- Connection of 3rd party sensors;
- Flow monitoring.

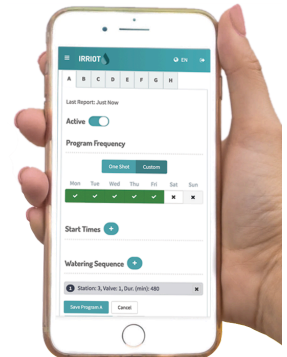

Latency and Open-Ahead

IRRIOT is a wireless network that operates a number of Remote battery driven nodes. The major challenge of today's wireless automation is to provide maintenance-free node operation under the whole season.

IRRIOT's Remotes harvest the solar energy with its compact but efficient solar panel. The energy is stored in a high-capacity rechargeable battery that can be used later at any light conditions.

A fully charged battery can provide several weeks of uninterrupted service without any additional source of light. The power efficiency is the major factor for full-time availability of the unit.

In order to spend as little electrical power as possible, the Remotes set themselves in sleep mode at any appropriate occasion. The Remote unit wakes up at network regulated intervals to perform sensor sampling and valve control. The rest of the time the Remote sleeps. It is not available.

This means that a command you order on a particular valve in the system is not executed immediately, but at the next scheduled communication. This causes

delays, or latency. These delays are completely normal, and are the direct consequence of power saving technology.

In order to calculate approximate range of latency in your particular network, the following rule of thumb applies:

- Installation with 6 or fewer Remotes: **30 sec**
- Installation with more than 6 Remotes: **$5 \times N$ sec, where N is the amount of installed Remotes.**

For example, you have an IRRIoT system with a Base Unit and 15 paired Remotes. The requested operation can be delayed in the range: 0...75 sec. Obviously the latencies differ for different Remotes, which may cause synchronization issues when opening and shutting valves.

IRRIOT has the feature that helps synchronize the Remotes. It is called Open-Ahead notification. Whenever possible, the information of the coming opening of the valve will be communicated to all related Remote Units in advance. So if you have a program that starts in 10 minutes, it is enough time to communicate the exact opening time for all the involved valves (*the Open-Ahead feature may be unavailable on older Remotes*).

The Open-Ahead notification is essential for functions like Master Valve ([see Chained Valves chapter](#)). It is also highly desirable when large volumes of water are moving and delays between subsequent valves may cause damage to the pipe infrastructure.

The Open-Ahead feature works:

- Scheduled program execution;
- Manual program execution, from RunTime 2 on;
- Delayed manual valve.

The Open-Ahead feature does not work:

- Manual valve;
- Manual program on the first RunTime

Conclusion: in the facilities where synchronized operation of valves is important, schedule all openings in advance, i.e. do not use plain manual operation.

Irrigation Rules

IRRIOT features unique flexibility in configuring the fully automated irrigation. The irrigation can be directly controlled by sensors, registered in the IRRIoT system, or can be set for sensor control during the user defined time schedule - automatic scheduled irrigation.

Automatic enabling/disabling of irrigation is achieved by **Irrigation Rules**. Irrigation **Rules can be applied to any RunTime**, primary or subsidiary, of the Program. Irrigation Rule represents a constraint to the scheduled duration of the RunTime. For example, a soil moisture rule greater than 35% interrupts the RunTimes that it was assigned to as soon as the moisture reaches 35%. When the rule is triggered the ongoing RunTime(s) transit from watering to idling state.

As opposed to On-Demands and Program Start Conditions, Irrigation Rules interrupt ongoing irrigation when fulfilled.

Irrigation Rule is a combination of parameters that include:

1. Sensor (Base, Remote or Extension connected)
Any sensor detected in the system can be assigned to an irrigation rule;
2. Mode of operation
The rule can be configured in different modes:
 - a. **Inactive** - rule is disabled
 - b. **Active** - regular
 - c. **Corr** - rule is in corrective mode
 - d. **Suspend** - rule suspends the program
3. Trigger level (logic and threshold)
Defines what fulfills the rule
4. Reset level (optional)
Creates hysteresis when resetting a fulfilled rule

The user can create up to **50 different Rules**. Up to **5 different Rules** can be assigned to a **RunTime of a Program**.

Notice that the irrigation rules apply to scheduled irrigation only, i.e. to automatic programs. The programs run in manual mode are not subject to any sensor automation. The manual programs will always run to the end.

The different modes of the **Rule** have different effects on program flow. When a Rule in **Active** or **Corrective** more triggers, the corresponding **RunTime** goes in idle state. The idle state means that the scheduled time continues passing with

the corresponding port shut. When a Rule in **Suspend** mode triggers, the remaining time of the current **RunTime** is stored in memory and the program is interrupted. When a **Suspend** Rule is reset the program is resumed from where it left.

Switch Rules

*Example: the rain sensor connected to **Base Unit sensor Input 1**. The user can create a simple rule and attach it to all the RunTimes irrigating zones exposed to rain. This suppresses watering during and after the rain.*

For a switch type sensor, the trigger logic is simple: either break or short circuit. Historically a switch type sensor is connected in series with the power supply, and when it triggers it breaks the circuit, causing a stop in the ongoing operation. Today most switch sensors are available in normally open and normally closed variants.

The condition with a switch type sensor would reset automatically when the trigger condition is no longer met. A switch can only have on and off state - when not on, it is off. Hence it is not possible to define Reset logic for such conditions.

Level Rules

More sophisticated rules have a level that has to be passed, in a predefined direction, in order to trigger this rule. For example a Rain Gauge sensor can be set to interrupt ongoing irrigation if the level reaches 15mm over the past 24 hours.

Another example is a soil moisture sensor that can stop the program if the level is at 36%. Such a rule will strive to keep the level of moisture constant at the defined value. How much the soil will dry between the watering occasions depends on external conditions and the frequency of watering occasions:

Daily watering occasions

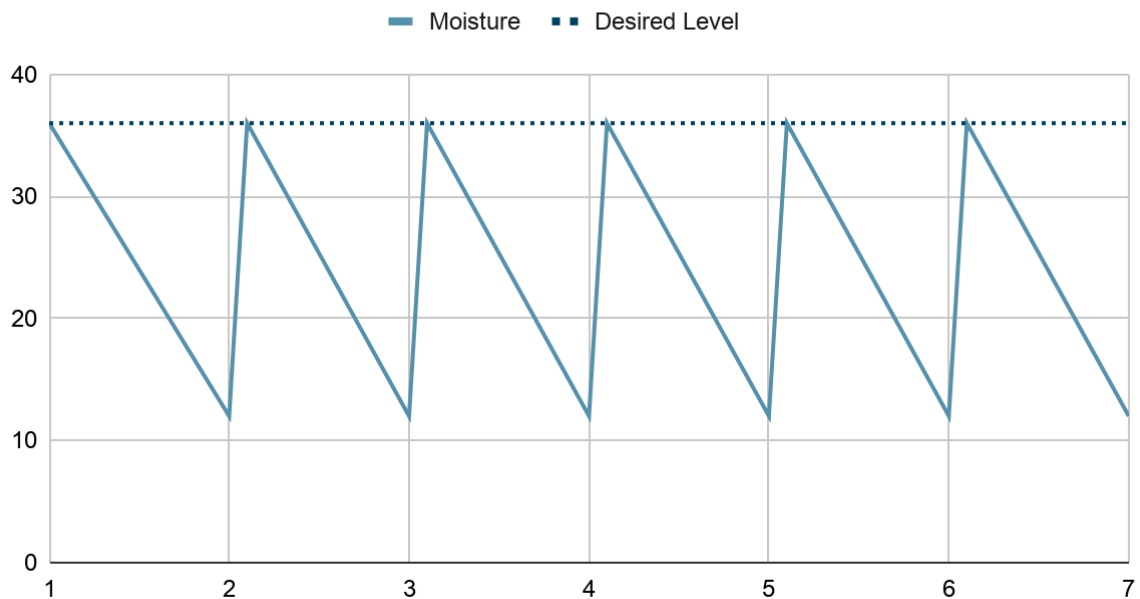

Bidaily watering occasions

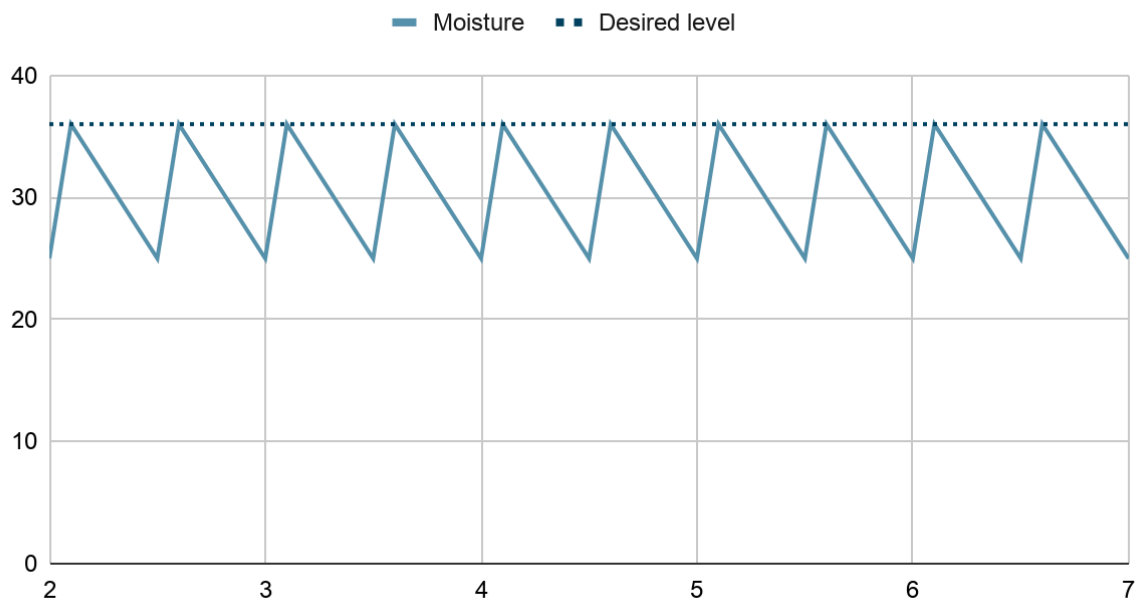

The rule is reset (becomes unfulfilled) as soon as the trigger level is no longer met. So there is no Reset logic and level defined for such rules. As soon as the moisture drops below the trigger threshold value, the rule is reset and the next coming irrigation occasion will take place as usual.

Range Rules

While the Level Rules is a natural way of automating, in many cases they are not sufficient. Consider for example frost protection. The automation is activated when the temperature drops below 1C. With the Level Rule as soon as the temperature rises above this level, the valves are shut. This will do damage to the crops. The proper automation would allow the higher temperature and ensure ice wash off before stopping the irrigation.

Similarly, at over temperatures the automation should allow the proper cooling of the plants before it is completed.

Even when it comes to the soil moisture, most growers do not want the same level of moisture at all times. When the plant is growing a certain level of stress facilitates healthy development of the root system. So the automation should both moisturize the soil to the right level, and then dry it out as configured before irrigating again.

To fulfill the requirement of these more sophisticated scenarios, the Range Rules can be used. A range rule has **Trigger** level and **Reset** level set separately. The chart below illustrates range automation as an example of leaf cooling. The parameters for the rule are:

Sensor: **WS1.Temp (temperature sensor)**

Mode: **Direct Drive**

Trigger level: **"greater than" threshold 36°C**

Reset level: **"less than" threshold 26°C**

Leaf cooling. Direct drive

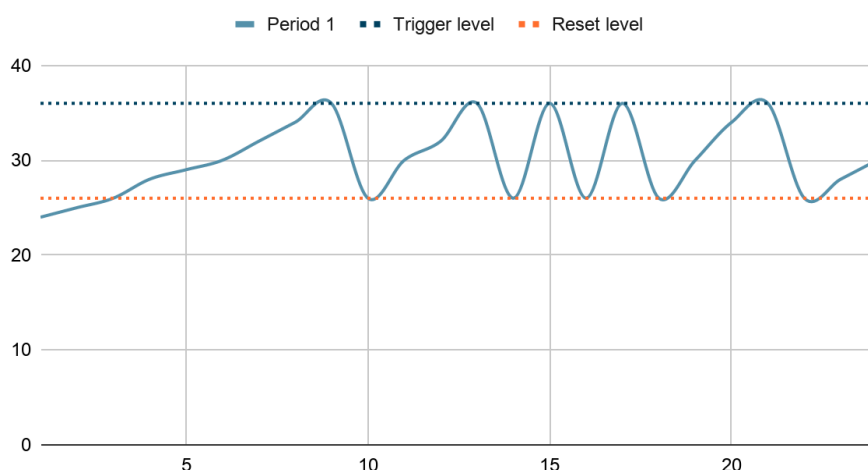

Sensor: WS1.Temp (temperature sensor)

Mode: ON (scheduled irrigation)

Trigger level: "greater than" threshold 36°C

Reset level: "less than" threshold 26°C

Scheduled irrigation program at 11:00, 12:00, 13:00, 14:00 and 15:00.

Leaf cooling. Scheduled Irrigation

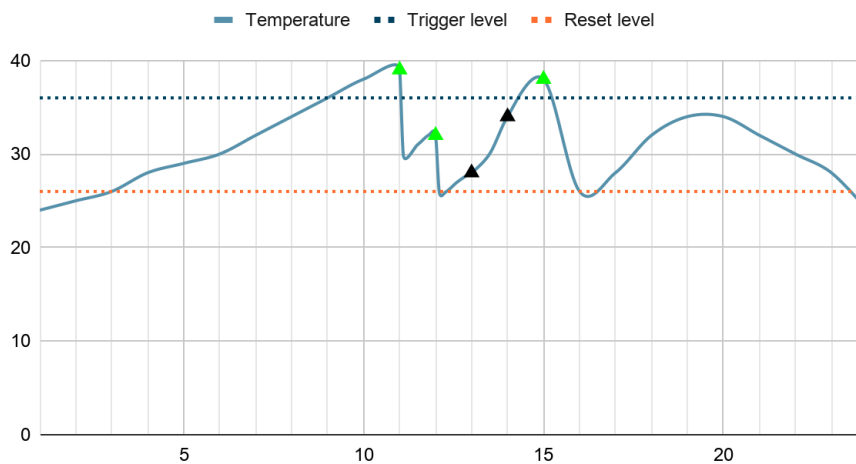

Notice that cooling at 11:00 did not reduce the temperature to the Reset level. So at 12:00 the cooling continued until the Range Condition was reset. The temperature started to climb. However at 13:00 and 14:00 the trigger level was not reached, and the watering was skipped.

Chained Valves (Master Valves)

IRRIOT supports simultaneous operation of the valves. There is no power related limitation on the amount of simultaneously open valves, as is in the wire based solutions. Of course, the water supply capacity still applies. The user can open manually any number of valves at the same time. The user can also start up to 15 programs at the same time.

In addition to this IRRIOT features a unique configuration called Chained Valves. Any valve in IRRIOT can be assigned the next valve in the chain, which in turn, can have yet another valve chained and so on.

A chain can have various topologies.

Horizontal Chain

At times when some valves should always open together, constituting a single zone, a horizontal chain can be configured (the red dotted line is the link of the chain):

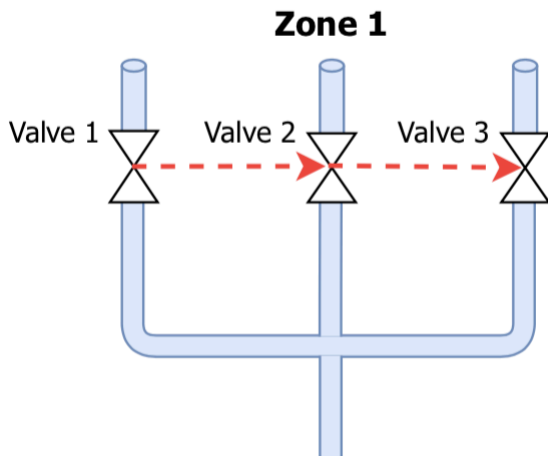

In the horizontal chain the **Valve 1** is at the head of the chain. Opening this valve will automatically engage the **Valve 2**, and the **valve 3**. When configuring an irrigation program the **Valve 1** is all you need to add as a **RunTime**. The **Valve 2** and **3** will be operated for the same amount of minutes.

*Notice that if you open the **Valve 2** the **Valve 3** will also open, but not the **Valve 1**. The valves are linked down the chain.*

Vertical Chain (Master Valve)

The main application of the vertical linkage is the **Master Valve**. IRRIOT supports multiple levels of master valves.

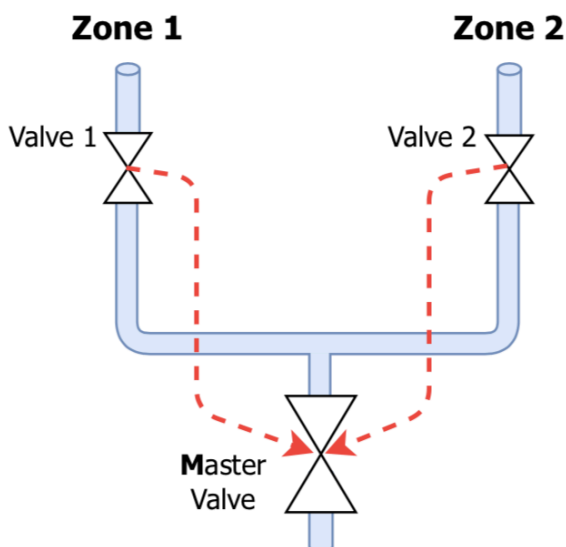

*Notice that opening **Valve 1** causes the **Master Valve** to open, but it does not open the **Valve 2**. The **Master Valve** will remain open until all the valves uplink are shut.*

Given below is an example of the multi level Master valve topology:

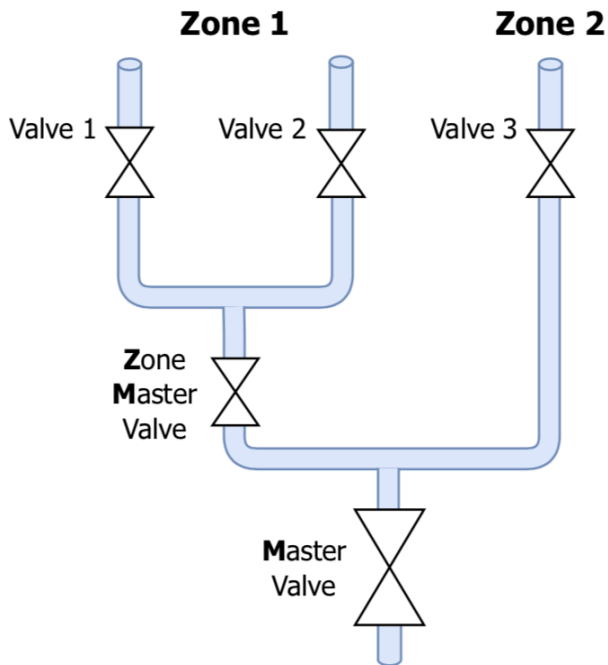

The following linkage should be configured to operate this topology:

```

Valve 1->ZM1
Valve 2->ZM1
ZM1->M
and
Valve 3->M

```

Hybrid Chain

In its most advanced form both horizontal and vertical topology can be combined. Consider the above example, but **Valve 1** and **Valve 2** run simultaneously.

```

Valve 1->Valve 2
Valve 2->ZM1
ZM1->M
and
Valve 3->M

```

Effect of Delays

Operation of a chain can be affected by delays between different Remotes. The delays are the result of unavailability of the Remotes in sleeping mode (so called beacon behavior). Please see the [Latency and Open-Ahead](#) chapter.

The open-ahead notification functionality addresses the latency issue. This will provide the synchronous operation of the valves connected to different Remotes. Notice that the open-ahead notification is only possible if the Base Unit still has time to deliver the notification of the coming opening.

Keep in mind that in manual mode, there is no way to warn the chained valve's Remote about the coming opening of the head valve. All the involved Remotes will be informed as soon as possible, but the linked valve can open both before and after the head valve, which reduces the actual watering time.

When running a program in manual mode, the first watering zone cannot be synchronized, but all the following **RunTimes** usually have sufficient time to get informed and hence synchronized.

Water Metering

IRRIOT supports potential-free (also known as dry contact) water meters. A water meter generates output pulses with the frequency proportional to the flow through the meter. In IRRIOT a water meter can be connected to a Remote (RTU) or to the extension module MPE6-4 in the Base Unit, if mounted.

The water meter is connected to the sensor input of the Remote, and is automatically detected as a water meter. However the water meter can have different amounts of liters per pulse, depending on the model, and it has to be configured.

As soon as the water meter is connected to the Remote, the Remote starts counting the pulses. The counter is not resettable and is stored in the non-volatile memory of the Remote Unit. When a meter is connected the counting continues from where it stopped. The counter cannot be converted to liters or m³ until the liters/pulse parameter of the meter is specified.

Notice that the counter is in the **Remote Unit (RTU)**, not in the physical water meter, although the water meter itself has the non-resettable counter, it will not match the counter IRRIOT shows. If you connect the same water meter to another Remote the counter will show a different value. Depending on whether a water meter (or Rain Gauge) has been connected to this Remote or not, the counter may or may not start from 0.

With all the above in mind, it is recommended to think through the water metering setup from the beginning (which Remote should control it), and stick with it.

In addition to the non-resettable counter, the user can define a resettable one, similar to the trip counter in a car. The resettable counter can be used for example at the beginning of season to monitor seasonal consumption.

There are three independent tasks that a Water Meter can perform in the facility:

1. Measure the total volume that passed this meter;
2. Determine the flow on an individual valve in run time, and monitor overflow and underflow conditions;
3. Determine leakage.

Common Topologies

The Water Meter accumulates the total volume of liquid that passed through it. However the same meter can determine the flow passing through other outlets providing that it is the only opening at the moment. A centrally located water meter can measure individual flows for all the valves in the system, providing that they are opened one at a time.

The typical considerations when determining the amount and placement of the water meters in the facility are:

1. Do you need a billing point? Measuring the total withdrawal from the source;
2. Do you need the monitoring of the overflow and underflow on an individual valve?
3. Is leakage detection required?

The monitoring of individual valves is only possible if no other valve associated with the meter is open at the same time. In some cases, the linked valves (see Chained Valves) can be regarded as the same valve, but the reference flow should be properly determined.

Depending on the capacity of the water source, one, two or many valves can be operated at the same time. The right placement for the water meter(s) is the point where all the valves downstream are opened one at a time. The exception is the statically configured valve chains.

Configure Water Meter

```
EXT2 IN1
Type: CNT
Multiple:0.1
Aggregat:TOTAL
Use +/- to change
```

The water meter can be wired to one of the MPE6-4 extension modules in the Base Unit or connected to an RTU with a provided cable. In order to be able to configure a water meter connected to the extension module, the input port of the extension must be configured as a Counter.

The first step after the meter is connected, is to create and configure it in the Base Unit. To do so, go to the **Configuration | Water Meters** and select **Add Water Meter_** or press the “+” button to insert.

The important parameters in this configuration are the Wireless Station where you have just connected your meter as well as the amount of liters per pulse.

Once done the water meter starts presenting the accumulated volume. You can see the total counted volume and the resettable volume counter in the **Status | Water Usage:**

```
M-EXT2.1
Total,m3
3376.2
Since:2024-10-04
1.0
```

```
Water Usage
M-WS1 265m3
```

Additionally you can associate the under- and overflow thresholds in percent for the meter. These percentages apply to the reference flow of a port (valve or relay). Each port will have individual reference flow, but the under- overflow percentage will always apply.

Example:

M-WS1 has the underflow set at 50% and overflow at 150%. The meter is associated with valves:

WS3 V1: reference flow 100 m³/h

WS3 V2: reference flow 200 m³/h

The normal flow for the valves shall be:

WS3 V1: 50...150 m³/h

WS3 V2: 100...300 m³/h

For the flows outside the ranges the OVERFLOW or UNDERFLOW alarm is raised. The OVERFLOW alarm additionally results in shutting of the port.

Measuring Flow

The purpose of measuring flow through a port in real-time is to monitor the overflow and underflow conditions. When detected, an appropriate action is automatically performed. If the overflow is detected the valve is immediately shut, and the corresponding alarm is raised. In the underflow case the corresponding alarm is raised.

For the measurements to make sense, a reference (regular) flow should first be established. There are two ways of doing it:

- Run **Manual | Reference Flow** procedure. The measured value is available in the field **Flow** of the port settings (Extensions and Wireless Stations);
- Measure by some means (e.g. mechanical meter) and fill the **Flow** field in the port settings manually.

```
Ext1 Relay1
Master:    R1.2
Meter:     M-EXT2.1
Flow,m3/h 12.0
```

It is not uncommon that the flow drifts during the season. If this happens and causes an alarm, just run the **Reference Flow** procedure again to obtain the new regular flow. The **Reference Flow** resets the **Flow** value and ceases the overflow and underflow alarms, if any.

If the underflow or overflow alarms come up too often and under normal circumstances, align the corresponding threshold in the **Water Meter** configuration to allow more tolerance.

Normally, the overflow and underflow alarms cease when the flow improves. So you need to execute a regular flow for some minutes to let the Water Meter report the flow in the range. Alternatively you can cease the alarms by ordering **Reference Flow**. The amount of minutes to execute can be left 0. The alarms can also be reset through the Alarm list in the main menu.

If all you want is to see the flow in real-time, without monitoring the over- and underflow conditions, leave the **Flow** parameter for this port to 0. Of course the associated water meter has to be specified.

As earlier discussed, there can be many water meters in the facility. The user has to associate the port that requires flow monitoring with the appropriate flow meter.

This is done in the **Valve** configuration in the **Wireless Stations** menu and in Extension Module Output port configuration.

```
Ext1 Relay1
Master: R1.2
Meter: M-EXT2.1
Flow,m3/h 12.0
```

```
WS5 Valve
Master: --
Meter: M-EXT2.1
Flow,m3/h 12.0
```

The **Meter** presents all the **Water Meters** configured in IRRIoT in the facility. As far as a Water Meter is selected, the flow through this valve will be measured in m³/h in real time. The flow value will be displayed on the **Main Screen** whenever the valve is open.

Notice that there is slight delay between valve opening and when the flow is presented. It can require from 1 to 10 minutes to obtain the flow through the port.

```
SUN 2020-10-04 14:22
PRG-A MON 02:30
V6.1: 3m 2m3/h
```

In a general case the flow through a valve, controlled by **Wireless Station (WS) X** is measured by a **WS Y**. In order to obtain exact flow the **WS Y** should take two readings with a known time difference. The time difference is the reporting period of a WS in the facility, i.e. the volume reading is delivered to the Base Unit at the regular report time of **WS Y**.

The reporting period depends on the amount of deployed Remotes ([see Latency and Open-Ahead chapter](#)).

In order for the flow to be correct, the valve in **WS X** must be open at both readings of **WS Y**. This is the source of delay in determining the flow.

Once the flow is obtained, a new near real-time value will be calculated on every report from **WX Y** (the station that monitors the **Water Meter**). So looking at the **Main Screen** you can see if the flow is proper right now.

However, when the valve is executing reference flow metering (**Manual | Reference Flow**), the flow is averaged over the entire watering period.

Control of External Equipment

If the Base Unit is equipped with one of the extension boards (**RE-8 or MPE6-4**), the external equipment, such as pumps, agitators and 24VAC valves can be controlled by IRRIoT. Different extension modules have different amounts of output ports, but the configuration and usage are the same.

The output, dry contacts, can be used for direct control of the frequency controller of the pump. The output can also be used for providing 24VAC to the external equipment. For such cases a permanently powered **24VAC transformer** is connected in series with the output of the Base Unit. For operating ordinary 24VAC valves, the secondary winding of the transformer (60VA in this example) is sufficient.

For powering a pump/ramp, a 24VAC controlled contactor, rated for the required power should be considered. The relay contacts on the extension module should be wired to switch the control voltage of 24VAC from a transformer on to the contactor.

For wiring description refer to [Appendix B](#).

Backup Power

Additional function of the extension interface is to provide **backup power** to the **Base Unit**. A deep-cycle **12V battery of 55Ah capacity** should be wired to the board and will provision the **Base Unit** for at least one month, maintaining all the manual and scheduled irrigation during the time. Of course the battery also can be used as the main power supply, if the grid power is not available. If the Base Unit is normally powered from the mains the switch over to the backup battery in case of power outage is transparent for operation.

Autonomous Base Unit

In cases where operation of the entire IRRIOT installation, including the Base Controller and a 3rd party cellular router for Cloud connectivity, is planned at a location off the power grid, a Solar Power Plant is recommended.

Refer to IRRIOT Solar Plant Technical Specification document for details.

Firmware Upgrade

We at IRRIOT continuously develop new features and fix detected bugs. From time to time a new firmware version is pushed to all live installations.

As a user you do not need to do anything to assist the upgrade. Sit back and wait for the upgrade to complete.

A firmware upgrade consists of three steps. If you are near the Base Unit at the event of upgrade, you can validate those steps by looking at the LEDs on the unit.

STEP 1: Download the new firmware from the HUB to the stage I flash

This step is visible on the LCD display as **"FIRMWARE UPGRADE"**. *Do not push any buttons. Just wait for the download to complete. It may take several minutes;*

STEP 2: Store the currently working firmware in the stage II flash for occasional roll-back. *In this step the LCD screen is blank, the LEDs on the unit are in the running pattern from left to right;*

STEP 3: Move the new firmware from stage I flash to the MCU main flash and restart. *In this step the LCD screen is blank, the LEDs on the unit are in the running pattern from right to left.*

If a failure occurs during **STEP 1**, the old firmware will continue to operate. There will be an alarm on the failed upgrade. To reset this alarm, and start a new upgrade attempt, select **System OFF** in the menu. **System OFF**, apart from its main function of disabling all irrigation, also resets the upgrade failure counter.

If a failure occurs during **STEP 2** or **3** the recovery happens automatically.

Notice that Firmware Upgrade requires connectivity with the IoT hub. The Base Units that do not have internet connectivity (no WiFi Dongle) cannot be upgraded with the new features remotely.

Usage

Main Screen, Navigation, LEDs

Main Screen

The Base Unit is equipped with an 8-line LCD display, also called the **Main Screen**. The backlight of the display is controlled by the timeout. When the **Base Unit** is powered up the backlight is on. After the period of inactivity of approximately 2 minutes the background light is automatically put out.

If the background of the display is not lit, the user has to push any button to light it first. Then the buttons can be used for normal menu navigation.

The **Main Screen** can be in one of two states:

1. Idle State
2. Menu State



In Idle state the **Main Screen** displays the current status of the IRRIOT system, as well as the scheduled irrigation occasions. The idle state is the default state upon power-up.

The display also falls back to the Idle state from the Menu state either upon a completion of configuration or upon a timeout - a period of inactivity for approx. 2 minutes.

Notice: The timeout is not activated inside a configuration page. In such a case the user has to go back manually to the Menu or all the way to the idle screen.

In the Idle state the display is partitioned in the following way:

SUN 2020-10-04 14:22	←	Current Date and Time
RAIN SENSOR	←	Triggered Conditions
PRG-A THU 14:20	←	Scheduled Irrigation
ALR WS2 LOST	←	Alarm
V3.1: 12m		
V9.1: 20m		
V24.1: 45m		
V31.4: 78m	←	Ongoing Irrigation

The lines *Triggered Conditions*, *Scheduled Irrigation* and *Alarm* are all **multi value strings**. If there are more than one value, for example multiple alarms, the multi value string will iterate through the values, using an internal timer. A multi value string can hold up to 33 text values. In some marginal cases the amount of corresponding items can exceed the capacity of a multi value string, in which case the exceeding items are not included and will not be displayed.

When the irrigation is ongoing, the bottom 4 lines of the screen display the watering zones. Notice that there are only 4 lines available for the purpose. If more than 4 ports are open at the same time, the open ports are displayed 4 at a time with a 3 sec interval.

Each line of the ongoing consists of:

Vx.y - the active valve, where **x** is the wireless station number (RTU), **1..32**, and **y** is the valve number, **1..4**.

Or

Rx.y - the active relay output port, where **x** is the slot number of the extension module, **1 or 2**, and **y** is the port number, **1..8**.

MON 2021-02-02 14:22	
RAIN SENSOR	
PRG-A THU 14:20	
ALR WS26 LOST	
V9.1: 10m	
V15.3: 20m	

Followed by the amount of minutes of irrigation left. When applicable the current measured water consumption in m³/h will also show on this line. If the measured value is not available but the Reference flow for the port is defined, the Reference flow will be displayed.

Navigation

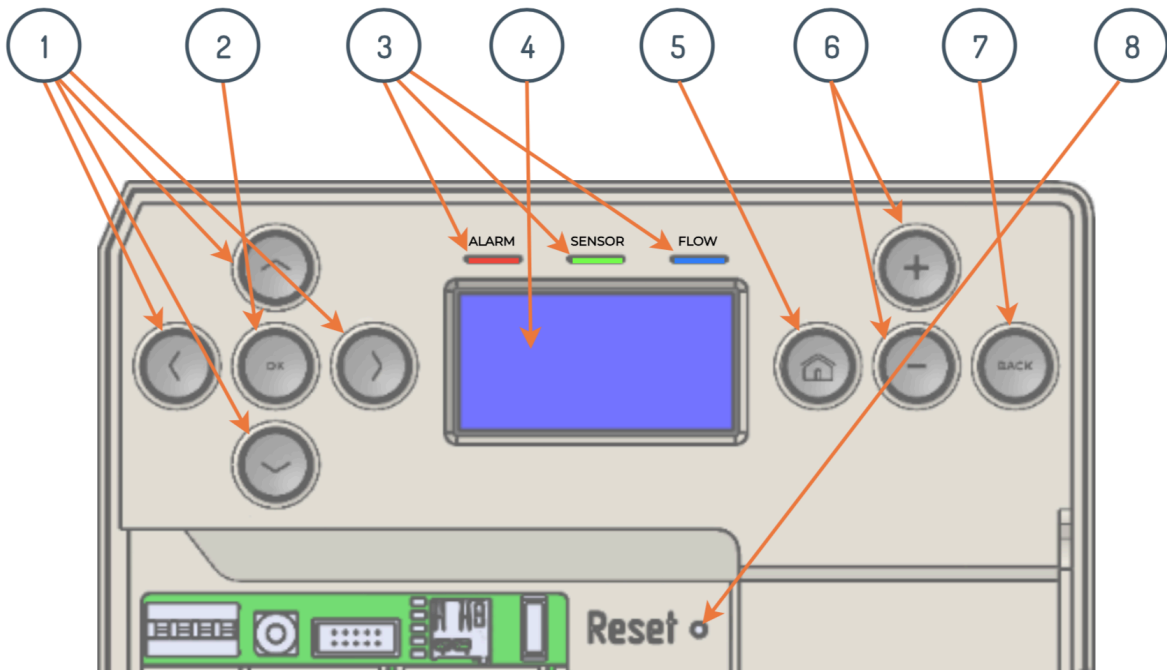

IRRIOT BSPB 1-128 Irrigation Controller

1. Navigational buttons $\leftarrow, \rightarrow, \uparrow, \downarrow$, to navigate through the menu - LEFT, RIGHT, UP and DOWN;
2. **OK** (Enter) button to confirm an action;
3. LEDs – **Alarm, Sensor, Flow**;
4. **Display (Main Screen)** shows current information and allows to navigate through the menu;
5. **Home** button, to return to the **Main screen**;
6. **+**, **-** buttons, to increase/decrease values or to insert/remove items like **StartTime** and **RunTime**;
7. **Back** button, to return to the previous menu;
8. **Reset** button.

Notice, if the background of the display is not lit, the first push on any button will only light the background.

When the user presses the **OK** button, while in the Idle state, the **Main Screen** enters the **Menu** state, where the configuration of the system is done.

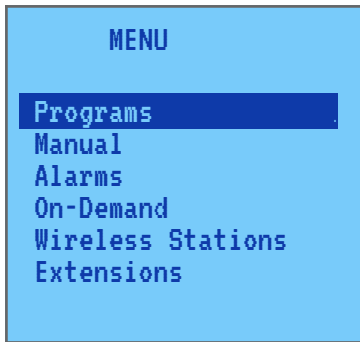

The menu has multiple levels. Use the arrow buttons on the left hand side to scroll up and down the items. To enter an item press the **OK** button. To come one level up press the **Back** button. When the **Back** button is pressed in the main menu (highest level) the Menu state is quit and the LCD returns to the Idle state.

All the buttons have the press-and-hold function to accelerate the action. For example if you want to quickly scroll down the menu, press and hold the **Down** button.

Important: the **Home** and **Back** buttons have special functions in *press-and-hold* mode. When you press-hold the **Home** button in the **Wireless Station** list menu, a restart request is sent to the selected wireless station:

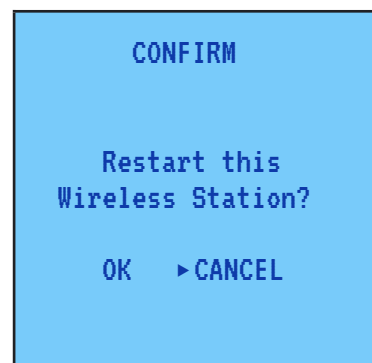
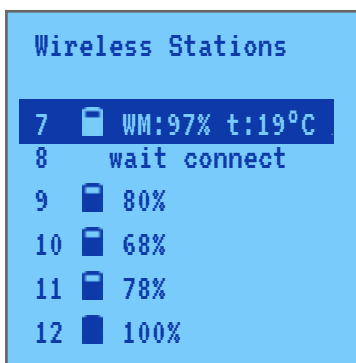

Press-holding the **Back** button in the **Wireless Stations** menu causes the selected wireless station to switch between operation and pairing modes. If the wireless station position is vacant (not paired) the pairing mode is activated:

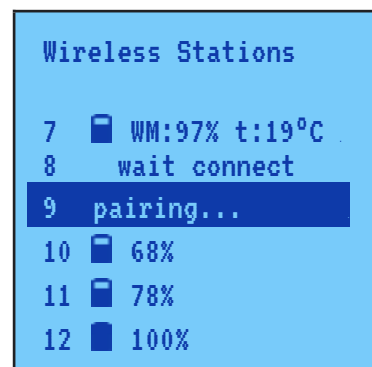
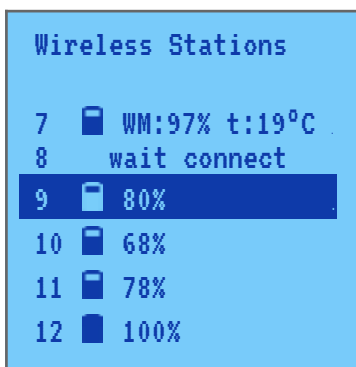

To quit the **Menu** state from any depth and return to the Idle state just press the **Home** button.

The **(+) Plus** and **(-) Minus** buttons are used inside configuration screens to iterate through the range of values, as well as for insertion and removal of items in the menu when applicable. In the menus where items can be added/inserted/removed, for example **Program Start Times** menu, the **Plus** button can be used for adding/inserting a new value. The **Minus** button can be used to remove the selected item.

The **Plus** button inserts a new item before the currently selected item, when applicable. Notice that sometimes the sorting of the items is predefined, e.g. Start Times in a program are sorted by the time.

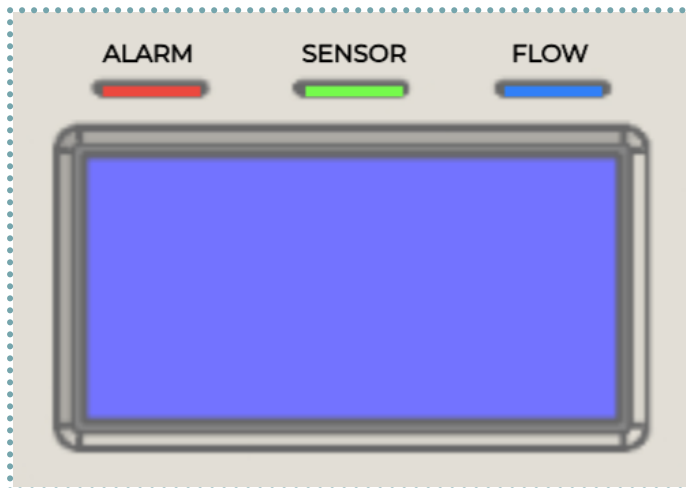

The Base Unit has three LEDs on the front panel. Upon power up, all three LEDs are illuminated for approx. 2 seconds.

There is one special case, the firmware upgrade, that uses the LEDs for indication of the progress of the upgrade procedure. See [Firmware Upgrade](#) for more info.

Alarm LED

The red colored LED is the alarm LED. It is flashing when there is any outstanding alarm in the system. When the LED is flashing, the alarm line on the screen sequentially displays all the detected alarm conditions. For the complete list of possible alarms and the recommended measures see Appendix A.

Notice, there is slight delay after the last alarm disappears and the LED is put out.

Sensor LED

The green colored LED in the middle indicates if there is any triggered automation condition. See chapter [Automation Conditions](#) for more info.

When the LED is lit the line for triggered conditions sequentially displays all currently triggered conditions.

Flow LED

The blue LED is flashing when any irrigation is taking place.

Notice that sometimes the valve that is supposed to be open is not open due to some triggered automation condition. This however does not affect the LED. The LED is flashing through the time the valve is idle.

Manual Operations

There are three options to run manual operations: **Manual Port**, **Manual Program** and **Reference Flow**.

Manual Port will let you open any **port (relay or valve)** for a certain amount of time, either immediately or at a configured time later.

Manual Program will let the user run any of the previously setup programs immediately. If a program is already running, **Manual Program** is a way to interrupt it. With the **Manual Program** you can interrupt both manual and ongoing scheduled programs.

Reference Flow will let you measure the flow (providing that a flowmeter is connected in the system) through a particular valve and relay port. *Notice that you can also set the port flow manually in the **Valve and Relay Settings** sub-menu in the **Wireless Stations and Extensions** menu respectively.*

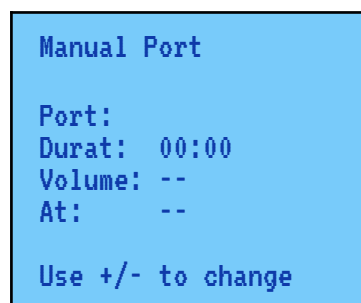

To use **Manual Port** scroll to **Manual** and press **OK**, select **Manual Port** and press **OK**. Use buttons $\leftarrow, \rightarrow, \uparrow$ and \downarrow to navigate in the configuration menu. Use buttons **(+)** and **(-)** to select **Port** and desired **Duration**.

The ports are displayed in the following format:
Rx.y, where **x** is the number of the slot of the extension that hosts the **Relay port** and **y** is the number of the relay port

```
Manual Port
Port:    R1.1
Durat:   00:00
Volume:  --
At:      --

Use +/- to change
```

```
Manual Port
Port:    WS6.2
Durat:   00:00
Volume:  --
At:      --

Use +/- to change
```

Or

WSx.y, where **x** is the number of the **Wireless Station** that hosts the valve and **y** is the number of the valve on that Wireless Station.

If the user wants to postpone opening of the port to some later time (delayed manual), set the value of **At** to the desired **Start Time**. If the selected time has already passed today, the opening is moved to the coming day. If you wish to reset the value of **At** scroll the hour value until you see: **--:--**. This results in immediate opening of the valve for **Duration** time. In order to cancel the programmed delayed manual opening completely, set the **Duration** to **00:00** (the **At** is reset automatically).

In order to interrupt an ongoing manual watering, select the port from the list. The **Duration** shows the remaining watering time. Set it to **00:00**.

To confirm, press **OK**. To leave without change press **Back**.

```
Manual Program
Program
B
RUNNING...
```

To use **Manual Program**, scroll to **Manual** and press **OK**, select **Manual Program** and press **OK**. Use buttons \uparrow, \downarrow or **(+)** and **(-)** to select the Program. To confirm, press **OK**. The selected program will run right away. If the program is already running, it is indicated on the display.

The running program can be suspended or stopped. The suspended program can be resumed or stopped. You will receive a corresponding message when you hit **OK**. To leave without change hit **Back**.



Reference Flow is similar to **Manual Port**. The difference is that the **Base Unit** will first reset and then obtain the new water flow parameter for the selected port during the manual run. To obtain a more precise value it is recommended that the duration of opening for a reference flow is at least 10 minutes.

To run **Reference Flow** scroll to **Manual** and press **OK**, select **Reference Flow** and press **OK**. Use buttons $\leftarrow, \rightarrow, \uparrow$ and \downarrow to navigate in the configuration menu. Use buttons **(+)** and **(-)** to select the desired **Port** and **Duration**.

To confirm, press **OK**. To leave without change press **Back**.

Programs

General

A **Program** is a sequence of **ports (valves or relays)** that open in a predefined order at a user defined **Start Time**. Up to **15** programs (**A** to **O**) can be defined in the Base Unit (Controller).

A port is the collective name for wirelessly controlled valves and relays on the extension board. All ports are treated the same way regardless if it is a valve in the field or a port on the extension board. A port is sometimes referred to as a zone.

The two main concepts of a program are a **Start Time** and a **Run Time**. The **Start Time** is when the program is activated. The **Start Time** can be a specific time of the day or a time period. The **Run Time** is the duration of watering for a specific **port** (zone). At any given **Start Time** the Base Unit (Controller) will sequentially execute all the **Run Times** (zones) defined for the program.

The user can add up to **20 Run Times** to one program. These **Run Times** are called Primary Run Times.

Each **Primary Run Time** can have up to **8 subsidiary Run Times**. Subsidiary Run Times are the ports that open and close at the same time as their primary

Run Time. This way up to **9 valves** can irrigate at the same time from the same program.

A **Program** can have **0 to 8 start times**. The execution at all the start times is exactly the same sequence of ports, unless the program **Start Condition** or **Irrigation Rules** change between the start times, e.g. rain has fallen. See more in [Start Condition](#) and [Irrigation Rules](#).

```

Programs
A SAT 12:30 60m
B MON 02:40 120m
C WED 05:30 60m
D NO START 40m
E
F
    
```

To enter **Program mode**, scroll to **Programs** and press **OK**. Use buttons \uparrow, \downarrow to select the program. For example, select program **A**. Configured programs will indicate the nearest start occasion (if defined) and the duration of the entire program - the sum of all **Run Times**, scaled, if defined, according to the seasonal adjustment.

For example: A SAT 12:30 60m

Start Times

```

PRG A Start Time
Start At: 01:30
Rpt Until: 08:00
Rpt Times: 0
Full run: YES
Gap, min: 0
    
```

Start Time is when the program starts executing the watering sequence. The program can repeat the sequence a number of times per day if you define multiple **Start Times** or configure repetition options: **Repeat Until** or **Repeat Times**. If no **Start Time** is defined, the program can only be **executed manually**.

Optionally, for every **Start Time** the user can define the **Repeat Until** time. The period between the **Start Time** and **Repeat Until** time is when the program sequence will restart once the previous sequence has completed. Please see the picture below.

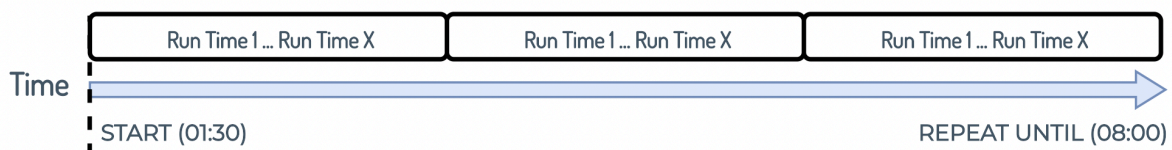

Notice that the **Repeat Until** time is not necessarily after the **Start Time**. If **Repeat Until** is earlier than **Start Time** it means the period is from **Start Time** until end of day and then overflows into the next day until the Repeat Until time. Please see the picture below.



The parameter **Gap**, if defined, is the time in minutes to be idle between subsequent repetitions within the time window between **Start Time** and **Repeat Until** time. Please see the picture below.

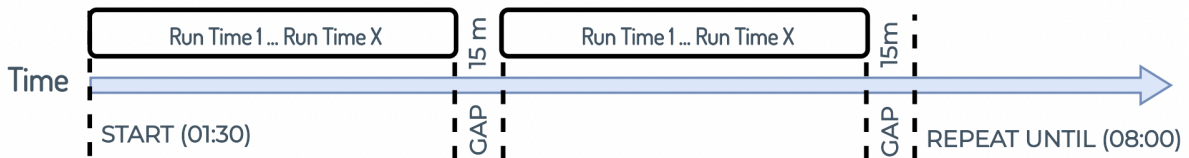

The parameter **Full Run** determines if the sequence should be executed even if it does not fit completely in the time left until **Repeat Until** time. When set to **YES** the sequence will not be started if it does not fit. If **NO**, the sequence will be started but interrupted at **Repeat Until** time. Please see the pictures below.

Full Run - YES example:

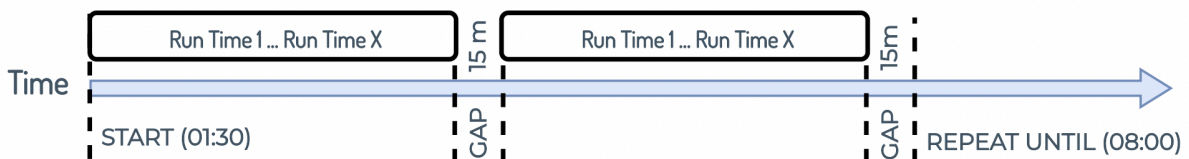

Full Run - NO example:

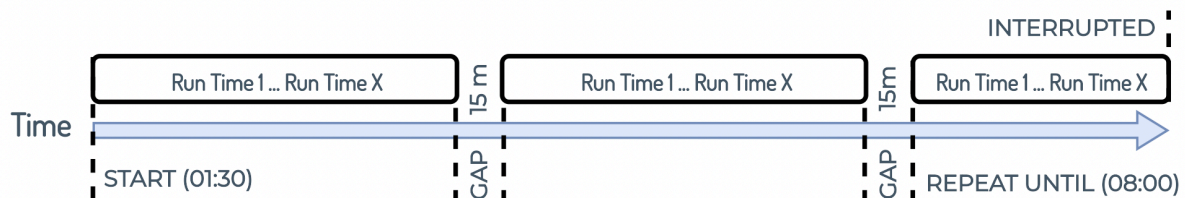

If the user defines the **Start Condition** for the program it will be evaluated before the start of the repetition. If the **Start Condition** evaluates to false, the repetition is not started until **Start Condition** is met. If the **Start Condition**

evaluates to **true**, the repetition will be **fully executed**, even if the **Start Condition** becomes **false during the repetition**.

Alternatively repetition can be defined in the **number of repetitions**. The repetition count cannot be configured at the same time as Repeat Until.

Start Time is when the program starts executing the watering sequence. The program can repeat the sequence a number of times per day if you define multiple **Start Times**. If no **Start Time** is defined, the program can only be executed manually.

IRRIOT Base Unit (Controller) supports **One-shot**, **Continuous** and **Every-N-day** execution modes. In a one-shot mode each start time is removed once the program has executed. Thus the program will not execute on consecutive days because there will be no start times defined. However, the program configuration remains. So it is easy to re-activate the program later either in one-shot, continuous or every-N-days mode by simply adding one or more new start times.

```

PRG A Start Time

Start At: 10:00

Rpt Until: --:--
Rpt Times: 0
Full run: YES
Gap, min: 0
    
```

First, setup **Start Times**, this is a starting point for the program. Let's say user wants to start irrigation at 4:00 in the morning and will use *Station 1 Valve 1* for 30 min, *Station 4 Valve 1* for 60 min and *Station 8 Valve 2* for 40 min, then your program **Start Time** is 4:00, all selected valves will operate sequentially, in numerical order, for the specified time, so user doesn't need to calculate time for each Station/Valve.

To set up **Start Times**, select **Programs**, select Program (A), **Start Times** and press **OK**.

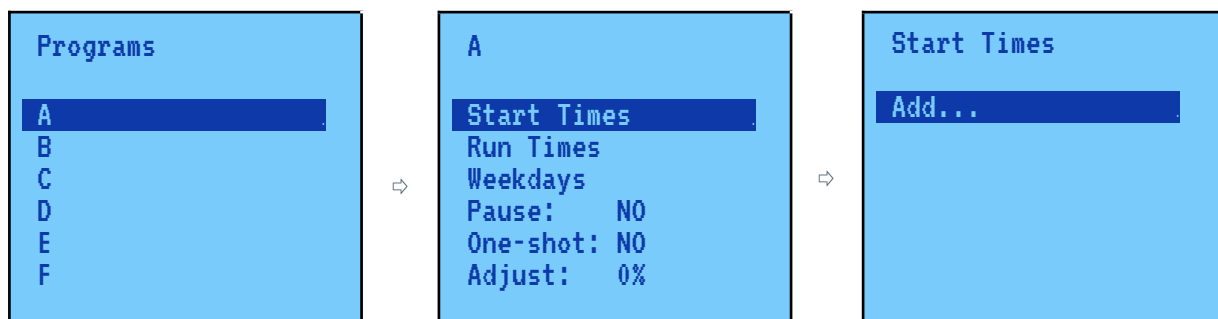

Add... press **OK**. Use buttons $\leftarrow, \rightarrow, \uparrow$ and \downarrow to navigate in the configuration menu and **(+)** or **(-)** to select desired **Start Time**. To confirm, press **OK**. Users can add **Start Times** by selecting **Add...** from the **Start Time** menu if they need to repeat the same program several times.

A **Start Time** can also be added by pressing the **(+)** button while in the list of **Start Times**.

To remove a **Start Time**, select it in the list and press the **(-)** button. A **Start Time** can also be removed by selecting the time **--:--** in the configuration screen.

Run Times

Run Time refers to a particular zone (valve) to be irrigated under user defined duration. The **Run Times** (zones) within the same program always execute sequentially.

The longest irrigation duration for a single zone, a single **Run Time**, is *23 hours 59 minutes*. The sum of all **Run Times** in a program should not exceed the shortest time between two consecutive Start Times, or, if there is only one Start Time in the program, should not exceed *23 hours 59 minutes*. If the sum of all **Run Times** overflows into the consecutive **Start Time**, an error message is displayed:



Sometimes it is desirable to open more than one valve at a time. This is possible using **Subsidiary RunTimes** within the same program (see also [Chained Valves](#)). It is also possible to execute multiple programs at the same time.

To set up **Run Times**, select **Programs**, select Program (A), **Run Times** and press **OK**. **Add Port...** press **OK**.

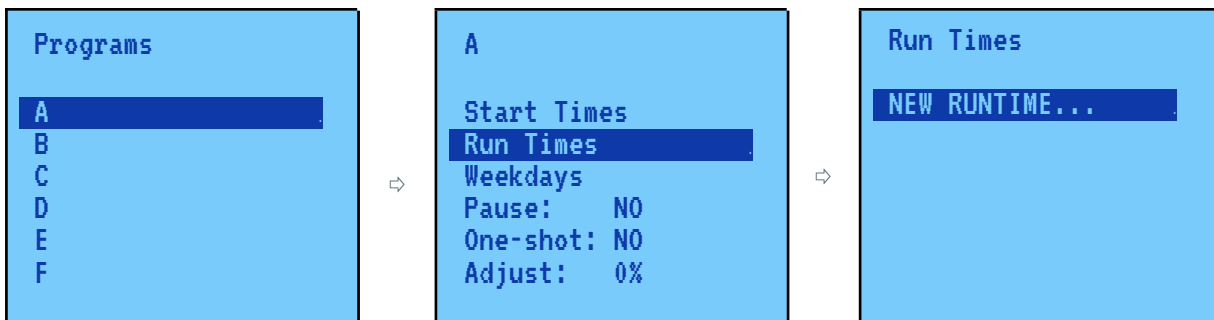

Use buttons \leftarrow , \rightarrow , \uparrow and \downarrow to navigate in the configuration menu and **(+)** or **(-)** **Port** and **Duration** duration (*up to 23 hours 59 minutes*). To confirm, press **OK**.

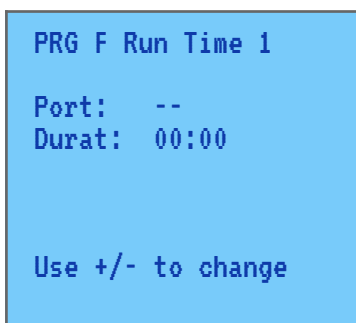

Users can add more Ports by selecting **NEW RUNTIME...** from the **Run Times** menu. During the program they will operate sequentially in numerical order.

A **Run Time** can also be inserted at the desired location by pressing the **(+)** button while in the list of **Run Times**. The new **Run Time** is inserted before the currently selected **Run Time**.



This is all that needs to be done to add a zone to the watering sequence. But the **RunTime** has more options. Select the **RunTime** and hit the **OK button** to see the additional configuration.

RunTime Options:

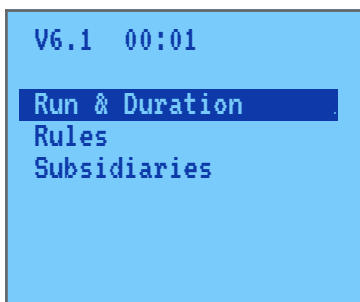

The header indicates current port and duration of the RunTime:

V6.1 - valve 1 on Wireless Station (RTU) 6
00:01 - 1 minute watering time

You can change both port and duration in the **Port & Duration** menu.

The additional options include Irrigation Rules and Subsidiary RunTimes.

Enter the **Rules** menu and hit **ADD RULE...**

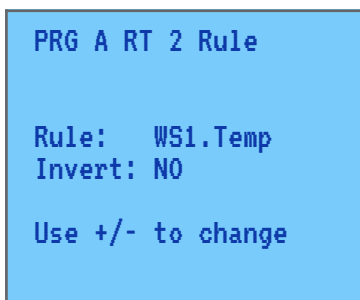
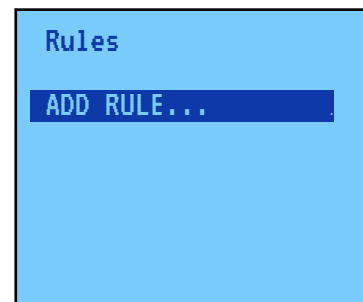

In the screen that appears select one of the defined **Rules** (*notice that you do not configure **Rules** here. This is done in the **Rules sub-menu** of the **Main menu***):

Up to **5 Rules** can be attached to a **RunTime**. Any of the **Rules** that becomes *fulfilled* interrupts the **RunTime** (*does not apply to manually started program*).

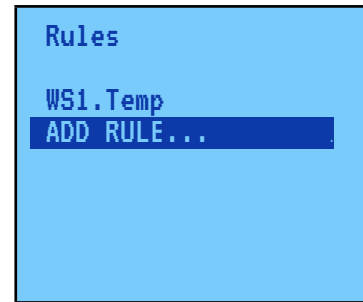

To remove a **Run Time**, select it in the list and press the **(-)** button. A **Run Time** can also be removed by setting the time to **0:00** in the configuration menu.

When a **Run Time** is added or increased, the situation of overflow can arise. The sum of all program's **Run Times** are not allowed to overflow into the next coming **Start Time**.

If multiple ports are required to be open at the same time the **Subsidiary RunTime** (or simply **Subsidiary**) is the best option to use. Up to 8 **Subsidiaries** can be added to the primary **RunTime** (also called **HEAD**). Both wireless valves and the extension module outputs can be defined. For example, an additional pump or a fertilizer channel, operated from the Base Controller itself.

To add a **Subsidiary** enter the **Subsidiaries** menu and select **NEW SUBSIDIARY...**

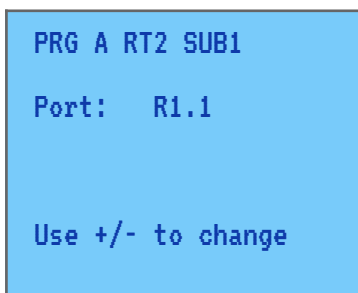
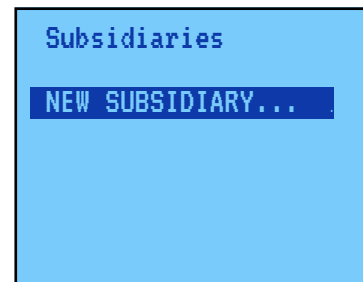

Similar to the primary **RunTime**, you select the **Port**. *Notice that there is no possibility to select the duration. **The duration of the primary RunTime applies to all its subsidiaries:***

In the list of subsidiaries the items are presented as the port and the primary **RunTime (HEAD)**:

R1.1 - Port: Extension module slot 1, Relay output 1 (**HEAD:V6.1**) - primary **RunTime** is valve 1 of Wireless Station (RTU) 6.

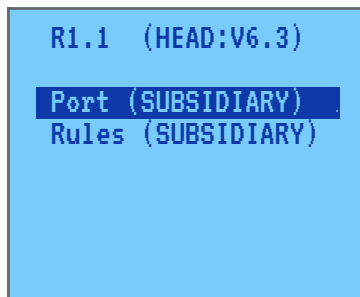
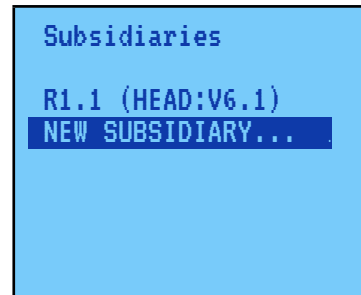

Once subsidiary is created you can select it and hit **OK button** to enter the menu with additional options:

The **Port (SUBSIDIARY)** is the screen where the port can be changed:
 The header of the menu comprises the following information:
PRGA - Program **A**
RT3 - RunTime **3**
SUB1 - Subsidiary **1**

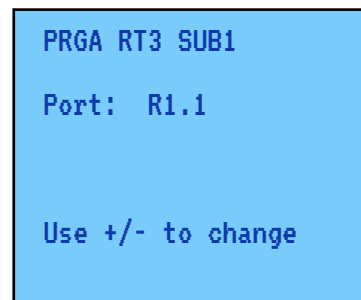

Notice that unlike the primary RunTimes subsidiaries cannot be duplicated and cannot duplicate its primary RunTime.

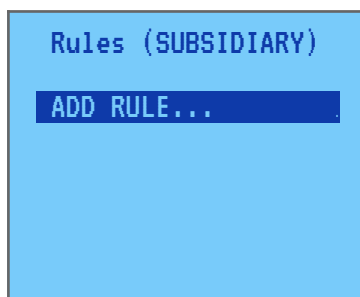

The **Rules (SUBSIDIARY)** allows to attach one or more irrigation rules to the **Subsidiary**:

Assignment of irrigation rules to the **Subsidiary** is similar to assigning irrigation rules to the primary **RunTime**:

```
PRGA RT3 SUB1 Rule1

Rule:  WS1.Temp
Invert: NO

Use +/- to change
```

When the rule assigned to a **primary RunTime** triggers the primary RunTime is interrupted, as well as all its subsidiaries. When the rule assigned to a subsidiary triggers it only affects this subsidiary.

To **remove a subsidiary**, select it in the list and press the (-) button.

Weekdays

A continuous program (i.e. not one-shot) can be configured to execute on certain **Weekdays**.

```
Weekdays
MON: ON
TUE:
WED: ON
THU: ON
FRI: ON
SAT: ON
```

By default a continuous program will execute on every day of the week. If you want to skip some of the weekdays of a continuous program, enter the program and scroll down to the **Weekdays** menu. In the list of the weekdays, switch **ON/OFF** particular days with the **OK** button.

Pause

A program can be paused for a predefined time.

```
A THU 12:20 25m

Start Times
Run Times
Weekdays
Pause: 24H
One-shot: NO
Adjust: 0%
```

To pause the program enter the program and scroll to **Pause**. Hitting the (+) button on the **Pause** menu increases the pause period by *24 hours*. You can increase the pause up to *96 hours*. Beyond this the **Pause** gets the value **YES** which means the program is paused indefinitely.

Notice: the pause hour counter is stepped down at the next hour shift. So if the pause is set to 24 hours, depending on what the current minute of the hour is, it may be lifted after 23 hours and X minutes instead of the full 24 hours.

Continuous Mode

This is the most common mode of irrigation. The user selects the weekdays when the irrigation should take place. The continuous mode is mutually exclusive with the other two modes: one-shot and every-N-days.

Interval Mode (every-N-days)

```
A THU 12:20 25m
Adjust: 0%
Weekdays
Interval: NOT SET
One Shot: NO
Start Condition
Reset
```

The program can be set to execute every **N days**. The every-N-days mode is mutually exclusive with the other two modes: one-shot and continuous.

The user can choose the repetition period from 1 to 7 days.

One-shot Mode

A program can be paused for a predefined time.

```
A THU 12:20 25m
Start Times
Run Times
Weekdays
Pause: 24H
One-shot: YES
Adjust: 0%
```

This option makes the **Start Time** of a program disappear after the execution of the program.

A **One-shot** program, like the continuous program, can have one of multiple **Start Times**.

To toggle between Continuous and One-shot mode push the **OK** button.

But if the **Start Times** of the continuous program are stored permanently, the **Start Time(s)** of a **One-shot** program are automatically deleted after the corresponding watering occasions.

*Notice that all other program parameters, e.g. **Run Times** remain. So in order to activate the program again, all you need is to set new **Start Time(s)**.*

Seasonal adjust

```
A THU 12:20 25m
Start Times
Run Times
Weekdays
Pause: 24H
One-shot: YES
Adjust: +20%
```

The **Seasonal Adjust** is an option allowing to increase or decrease every **Run Time** of a program by a number of %. The adjustment range is -90% ... +90% with the step of 5%. Use the (+) and (-) buttons to change the adjustment.

*Notice that when increasing the adjustment, the total span of the program can flow over to the next **Start Time**. This results in the following error:*

```
ERROR
Sum of RunTimes
overflows into next
StartTime

Hit any button
```

Start Condition

In addition to the scheduling options, such as Start Times, repetitions and gap, the Program can be constrained by a **Start Condition**. **Start Condition** is user defined *sensor levels* **that must be fulfilled** in order for the program to start execution during the configured time frame.

Configuration of the Start Condition is similar to On-Demand sensor configuration. **Any sensor** detected by IRRIOT, either connected to the Base Unit, extension module MPE6-4 or a Remote, can be assigned for program **Start Condition**.

When using simple Start Times the Start Condition is evaluated once at that time. If the repetition options are defined the Start Condition is evaluated every time the execution of the program is about to start.

It is important to note that Start Condition is not evaluated during program execution. So if the Start Condition is fulfilled at the moment the program starts, the program will execute to the end. The Start Condition has no effect during the program execution.

```
A THU 12:20 5m
Adjust: 0%
Weekdays
Interval: 3 DAYS
One-shot: NO
Start Condition
Reset
```

Select the desired sensor from the list of detected sensors. Define the Run and, optionally, Skip condition. If the Skip condition is not set (NONE) the program will not start if the Run condition is not true.

If the Skip condition is set the program may be started even if the Run condition is not true, the program will only not start if the Skip condition is true.

Consider the following example. A current loop sensor at IN1 on the extension module is selected to provide Start Condition for the program. The logic is set to run the program if the reading of the sensor is greater than 1.6. If the reading of the sensor is 1.7 or more the program will start at the defined Start Time (or Time Window).

```
PRG A Sensor
Sensor: EXT1:1.4-20
Mode: ACTIVE
Run: OVER 1.6
Skip: NONE
```

If the reading is less or equal 1.6 the program will skip the execution.

```
PRG A Sensor
Sensor: EXT1:1.4-20
Mode: ACTIVE
Run: OVER 1.6
Skip: UNDER 1.0
```

In this next example the Skip condition is set to 1.0. If the reading at Start time is over 1.6 the program is allowed to start. At the next start occasion (another Start Time or repetition) the program will be started even if the reading is equal or less than 1.6, e.g. 1.4.

The program will only be skipped when the sensor reads below 1.0, e.g. 0.9.

Reset

```
A THU 12:20 25m
Run Times
Weekdays
Pause: 24H
One-shot: YES
Adjust: +20%
Reset
```

Reset is a way to purge the program. All program data is gone. The Start Times and Run Times are purged. The program is set in continuous mode with 0% adjustment. The weekdays are all days.

Alarms

On the main screen there is a line dedicated to active alarms. On that line the alarms are displayed one at a time with the interval of a few seconds. In order to see and, if desired, reset alarms, there is also Alarm listing available in the main menu:

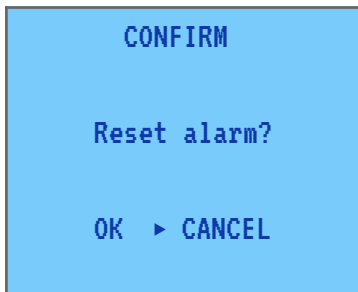
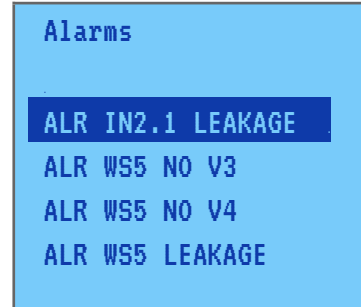

If you hit OK on the selected alarm the following message appears.

This provides a simple way of resetting the alarm. *Notice that this does not resolve the fault, just clears it.* So if the error persists the alarm will pop up again. This is a relevant way of resetting alarms, like UNDERFLOW, that otherwise are not easy to get rid of.

Wireless Stations (RTUs)

The Wireless Stations menu displays status of the paired wireless stations, and allows configuring various behaviors of the magnetic valves.

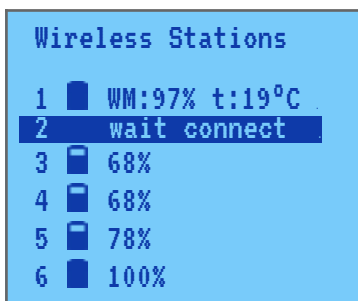

Initially the **Base** station has **32** vacant positions for connecting physical **Remote Units (RTUs)**, called Wireless Stations. Each RTU has a **unique ID** when delivered from the factory. In order for the Base Unit to recognize and control the Remote Unit, the Remote Unit has first to be paired with the Base.

At the pairing the Base and Remote Units exchange their unique IDs and the Remote Unit with its specific ID, the physical device, is assigned one of the wireless station numbers. After that whatever commands are sent to the

assigned wireless stations will be delivered to the associated physical device - the Remote Unit with the paired ID.

Pairing

Whenever possible the **RTUs are paired** to the **Base Unit** on delivery.

However, in some cases it will be hard to know in advance which wireless station number is the most practical to assign. So the installation person should do it instead. It is also possible to re-pair the RTU to another wireless station number. Additionally purchased RTUs will also arrive unpaired.

The procedure below describes the steps for pairing an RTU with the Base Unit.

When user want the RTU in hand to be a wireless station **X (WS13** in the example here), select the (vacant) slot in **Wireless Stations** menu and *press-and-hold* the button (**Back**) until the **pairing...** string appears:

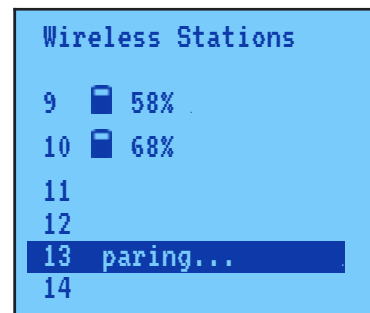

The Base Unit is now in pairing state and will accept pairing requests from an RTU. *The Base Unit will remain in the pairing mode until a successful pairing attempt from an RTU or timeout of 10 minutes.*



Only one wireless station (RTU) can be set for pairing at a time. If you try to set another wireless station in pairing an **ERROR** message will be displayed.

Now, with the **RTU in hand**, push the **pairing button** with a small screwdriver or a toothpick (a small push button under the back cover).

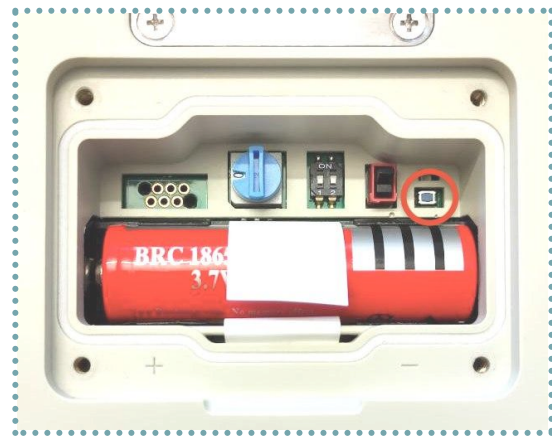

Important: if you just started the RTU, wait for the LEDs to turn off. Then pay attention to the pairing LED on the RTU when you push the pairing button. If, when you push the pairing button, the LED is steady on for a couple of seconds, then is off, this means you have succeeded. The pairing is now completed.

Unpairing

In some special cases you may want to unpair an earlier paired RTU from a wireless station number. You may, for example, want to change the wireless station number of a specific RTU.

Unpairing is a very simple process. Select the wireless station that has the RTU that you wish to unpair, *press-and-hold* the **(Back)** button until the corresponding message display:

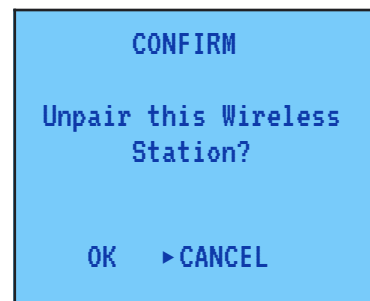

Notice that it may take a minute or two for the RTU to receive the unpair command. So please just wait.

Restarting RTU Remotely

It is possible to issue a **restart command** to a particular RTU. Restarting RTU is necessary after rewiring the valves in order for the RTU to re-discover the new configuration. Select the corresponding wireless station, **press-and-hold** the **(Home)** button until the message is displayed:

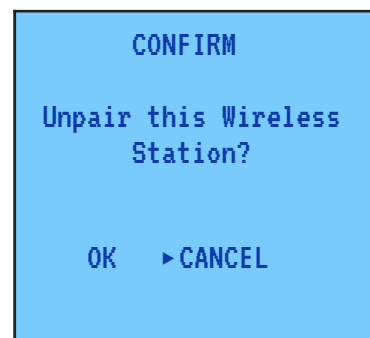

Wireless Station Configuration

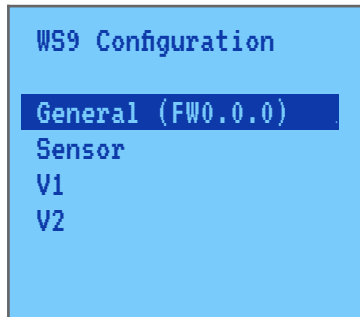

IRRIOT has **two types of RTUs: 2-valved and 4-valved**. The system automatically detects the type of the RTU and will display the appropriate amount of valves for a specific wireless station.

Notice that upon system start, the Base Unit does not know the capability of the RTUs until they first communicate with the Base. Until the first connection with the RTU has taken place, the Base Unit assumes that the RTU has 2 valves.

General

This configuration screen contains important status information of the wireless station:

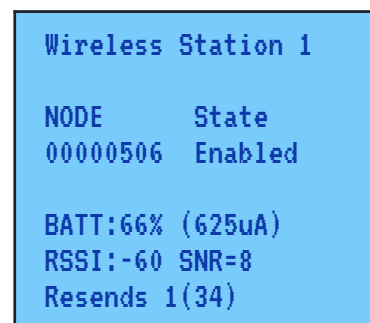

The **NODE** is the unique **ID of the RTU**. You can find this ID on the label on the back cover of the RTU. This value is assigned automatically during pairing and cannot be changed afterwards.

The State can be set to one of three values:

- **Disabled**

In this state the Base Unit suppresses error messages from this wireless station. This can be useful when the wireless station has finished for the season and the user wants to put it away. Normally the Base Unit continues to monitor the station and raise an alarm when it is gone. If the RTU has been switched off intentionally, by setting the station in Disable state the alarm "Wireless Station Lost" is suppressed;

- **Enabled**

This is normal operation state

- **Winter**

In the winterized state the RTU enters hibernation mode. The communication with the Base Unit is minimal. This allows us to save the battery charge level during winter months. Because the communication of the RTU with the Base in winter mode is so infrequent, setting the RTU back to normal mode (Enabled or Disabled) may take hours. It is therefore recommended to **Enable the RTU one day in advance** of the planned start of irrigation. It is possible to speed up quitting of the Winter state by opening the back cover of the RTU and resetting it by the rocker switch (the state in the Base Unit should be set to **Enabled** before doing this).

The **BATT** indicates the state of the battery charge level as well as the charging or discharging current amount. The following levels of charge are of interest:

- **approx.80%** - optimal storage charge;
- **>50%** - the Low Battery Alarm, if on, is ceased at this level;
- **<30%** - the Low Battery Alarm is raised at this level;
- **<15%** - the lowest operational charge. At this level the **RTU automatically shuts the valves** (if any open), and stops executing commands from the Base. The LEDs are permanently off. However the communication with the Base Unit continues as usual.

Following the state of charge it is the electrical current (in parentheses). The sign indicates the direction of the current. **The “-”** in front of the value means the battery **is discharging**. **No sign** indicates the battery **is charging**. The units differ depending on the scale of the value. It could be: **uA** (microAmp) or **mA** (milliAmp). $1\text{mA} = 1000\text{uA}$.

The charging current is limited by the RTU to **500mA max** (using external power supply). Because the RTU has an inbuilt charger you can use both a mobile charger with **Micro USB connector** and ordinary 5VDC power supply. The solar panel gives the charge between 0 and 100mA, depending on the outdoor conditions.

The **RSSI** is the Received Signal Strength Indicator. The parameter is in **dBm**. It is primarily for use at installation. The value is negative and the following somewhat subjective limits can be of interest:

- **>-70dBm** - the signal is extremely strong;
- **Between -90dBm and -110dBm** - the typical field conditions;

- **<-110dBm** - quite weak signal, but still might work stably. Check **Resends** parameter;
- **<-125dBm** - too weak signal. The RTU should be lifted higher up or an external antenna should be used on RTU.

The **SNR** is the signal to noise ratio. Typical values are 5..9, but generally, all positive values are good. A negative value (signal weaker than noise) may in some cases still work normally. Check the **Resends** value for more insight.

The **Resends** value is the ultimate indicator of connection quality. Unlike the **RSSI** and **SNR**, it is an accumulated value and it takes some time to get the proper reading. The value in parentheses is the amount of transmission failures during the past 24 hours. The following rules should apply:

- **<100 resends** per 24 hours: very good communication
- **<200 resends** per 24 hours: acceptable communication
- **>300 resends** per 24 hours: bad communication. May result in opening and closing delays, as well as **Action Timeout** Alarms.

Sensor configuration

IRRIOT has plug-n-play configuration for any sensor connected to an RTU. However the user may need to parametrize custom sensors.

By default a pressure sensor will be configured as **4-20mA 10 Bar** and a level sensor as **0-20mA 1 m**. What if the physically connected sensor has a different type or range? The user can configure it using the Sensor Configuration.

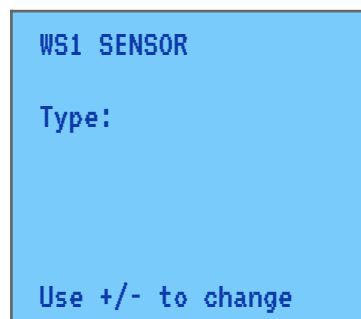

For example, we want to connect a **6 Bar 4-20mA** pressure sensor to **Wireless Station 1**. Select the **4-20mA** type.

When a type is selected the corresponding parameters are displayed. Now, select the Full Range:

```
WS1 SENSOR
Type: 4...20mA
Range: 6.0
Use +/- to change
```

Hit the **OK** button to store the parameters. The sensor configuration is stored in permanent memory. Notice that the reading from a sensor is obtained when the RTU is communicating with the Base Unit. It may take up to 3 minutes before you see the new configuration in action.

Notice, if the sensor configuration does not correspond to the detected sensor, the configuration will have no effect. For example, if a type for a pressure sensor is set to Counter. If the Range parameter is set to 0, it will also have no effect, meaning that the default metrics mentioned above will take effect.

Valve configuration

Following the general configuration of the wireless station, there is a list of valves connected to the RTU. The list will show 2 or 4 valves depending on the RTU model.

Settings

The following settings can be configured for every valve.

```
WS5 Valve
Master:  --
Meter:   M-EXT2.1
Flow,m3/h 12.0
```

For each **valve** the user can configure the **master port**, the flowmeter that shall be counting and monitoring the flow through this valve. Notice the flowmeter is configured separately in order to appear in this list. The flow for the valve can also be set manually in the interval 0 to 500 m³/h

IRRIOT supports multiple levels of master ports, i.e. a master port can have a master port, etc. The only limitation is that the chain of the linked ports must not create circular dependencies.

To browse through the list of valves use (+) and (-) buttons. *Notice that upon a system start the valves will appear in the list with certain delay. Please allow some head time before configuration.*

If the master port is configured for the valve it is displayed on the same line in format:

Rx.y, where **x** is the number of the **slot of the extension** that hosts the master Relay port and **y** is the number of the **relay port**

Or

WSx.y, where **x** is the number of the **Wireless Station** that hosts the master valve and **y** is the number of the **valve** on that Wireless Station.

Example: WS14.3

A chain can be used to make multiple valves open at the same time. All you need to do is to open the valve in the head of the chain. The head of the chain valve can also be put in a program.

The **Meter** is the **flowmeter** associated with the currently configured valve. If a flow meter is mounted in the facility it can be used for:

- A. Determining the reference flow for a particular zone;
- B. Measuring the real time flow in m³/h;
- C. Determine and alarm on underflow condition;
- D. Determine and alarm on overflow condition;
- E. Determine and alarm on leakage.

The **Flow** is a way to set the flow to the valve manually. Notice that a better way is to let the Flowmeter measure this value, using the Reference Flow manual operation. Obviously, to measure the real flow a flow meter should be installed. However, even if there is no flow meter connected to IRRIOT it is useful to have this value defined. This will allow us to monitor water usage over different periods, e.g. a week, a month, a season. If the flow for the valve is defined the watering time for it can be set both in minutes and in liters.

Status

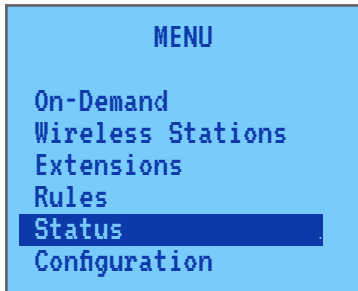

Status Menu displays status information. To enter the Status menu scroll down to Status in the main menu and press the **OK** button.

WiFi Status

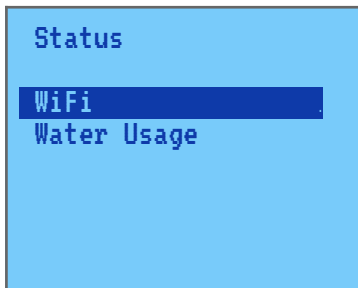

Select the **WiFi** to see the connection state of the **WiFi dongle**.



This menu displays the **SSID** of the configured WiFi network, the **IP-address**, the connection state and the signal strength **RSSI**. The signal strength greater than -85dBm is a good signal. If the signal is less than -85dBm, e.g. -90dBm, the connection may still be reliable, but the alarm **Weak WiFi** will be raised.

The last line on the screen shows Module type. There are two module types that are supported by IRRIOT: **ISM43362** and **WINC1510**. They have similar functionality, but have different connection procedures defined in corresponding tutorial videos.

The **MAC address** of the module is available in the **About** screen once connected.

Water Usage

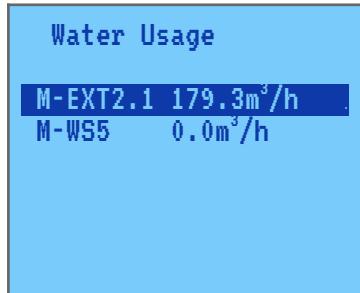

If one or more **Water meters** are connected to the **System**, this menu will show the real-time flow. Press OK on the selected water meter to open the summary menu of the water usage. You can also reset the resettable counter here.

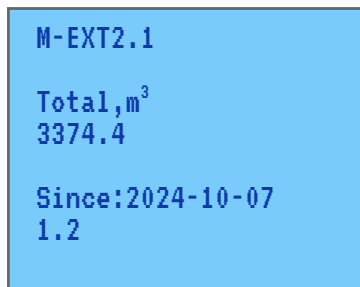

Press **+ or - button** to reset the counter.

On-Demand Irrigation

General

As opposed to scheduled irrigation, i.e. **Programs**, **On-Demand** irrigation or simply On-Demand is the irrigation mode driven solely by a sensor state. The user can define up to **50 different On-Demands**.

When using On-Demands the water supply should be dimensioned to withstand random water withdrawals. Typical applications for On-Demands include frost protective irrigation and misting.

When the user defined sensor Start condition is fulfilled the On-Demand opens all its defined ports. The ports will remain open until the sensor reset condition is fulfilled. The user can define up to **10 ports** for one **On-Demand**.

The user can limit **On-Demand** to a certain **time window**. Up to 5 non-overlapping time windows can be defined for one On-Demand.

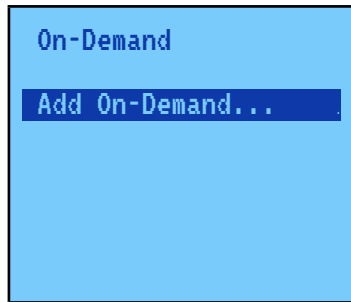
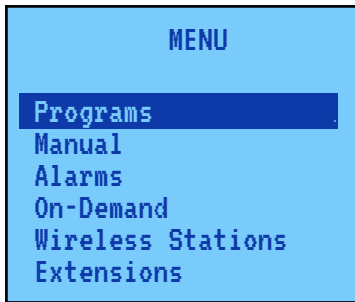

Sensor

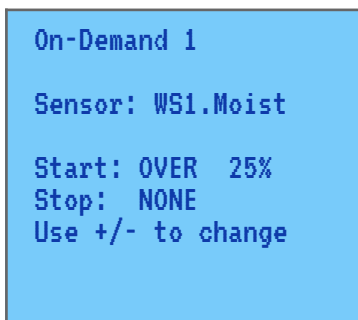

When creating an **On-Demand** the user first has to specify the sensor **Start and Stop conditions**. Select the desired sensor from the list of detected sensors. Define the Start and, optionally, stop condition. If the Stop condition is not set (NONE) the On-Demand stops as soon as the Start condition is no longer fulfilled.

Once the sensor condition(s) is defined the **other options** of the On-Demand become available:

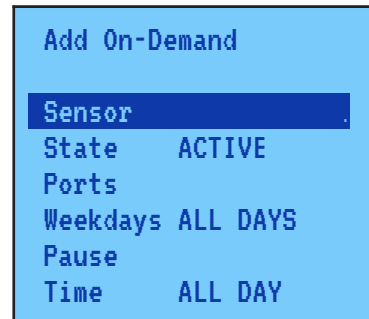

State

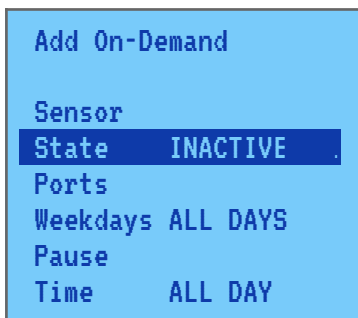

On-Demand can be in **ACTIVE** or **INACTIVE** state. When INACTIVE, the condition is not evaluated and the On-Demand will not start. An ongoing On-Demand will be interrupted.

Ports

This is the list of the ports that get open simultaneously when the Start condition of the On-Demand is fulfilled.

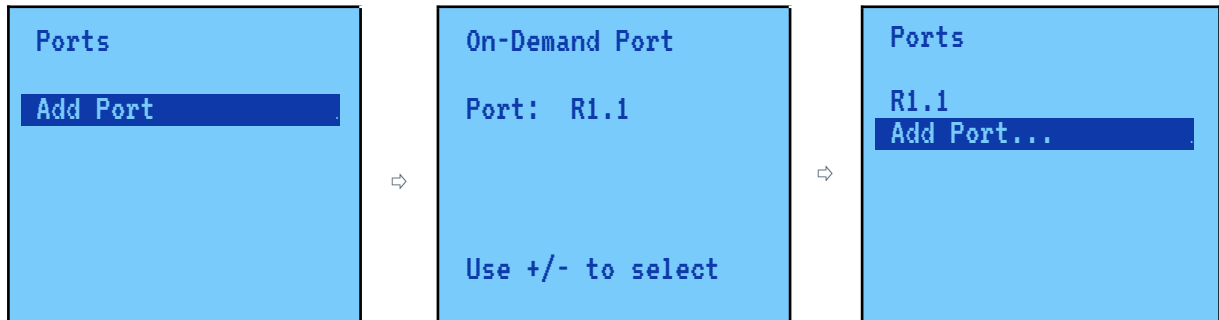

Weekdays

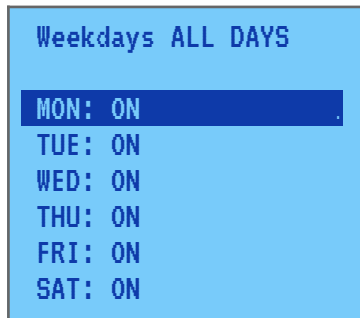

On-Demand can also be restricted to certain days of the week. **By default** the On-Demand is **active all 7 days** of the week.

Pause

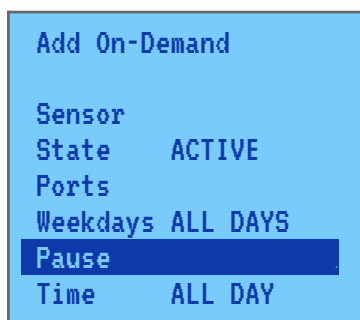

Similar to irrigation Programs On-Demands can be **paused** for: 1, 2, 3, 4 days or until canceled.

Time

On-Demand can be restricted to **specific time window(s)**. Up to **5 time windows** can be defined. By default, the On-Demand is active all day.

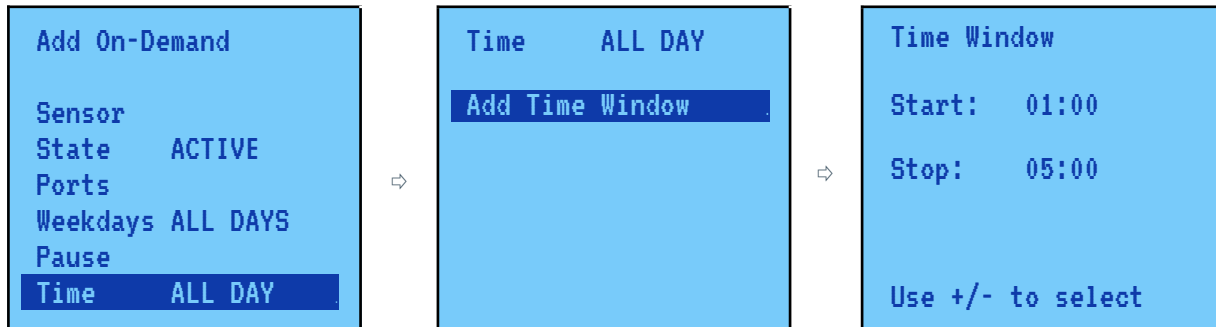

If the Stop time is earlier than the Start time, the On-Demand is active from the Start time until the end of the day and then until the Stop Time next day.

Extensions

Extensions menu lists the extension boards detected by the system. The Base Unit can host **one or two extension boards**.

There are three types of extension boards available for IRRIOT Base Unit:

1. **RE-8**
Relay Extension with 8 relay outputs
2. **MPE6-4**
Mixed Port Extension with 6 inputs and 4 relay outputs
3. Legacy pump control extension (2 relays)

The extension board is identified by the slot number. If the Base Unit is equipped with two extension boards they should be assigned different slot numbers.

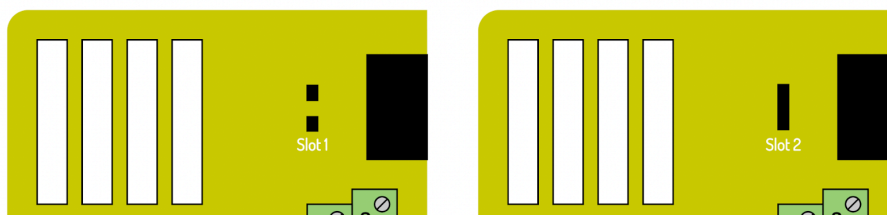

The Jumper switch is used to distinguish **Slot 1** and **Slot 2** used in the Controller, it's important when using 2 boards in one controller.

The detected extension boards can be configured through **Extensions menu**:

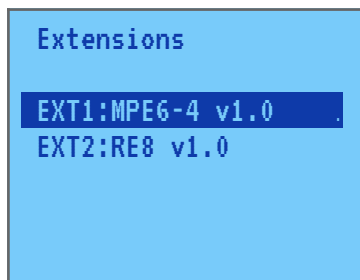
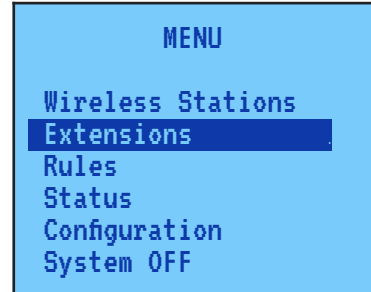

In this example an **MPE6-4** extension is detected in **slot 1**, and **RE-8** extension in **slot 2**.

Configuration of the output ports on **MPE6-4** and **RE-8** is the same. They only differ in the **quantity of outputs**.

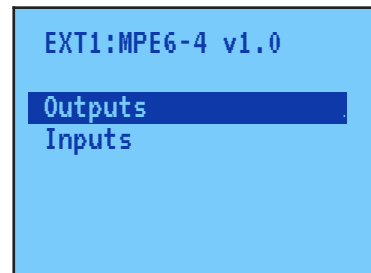

Relay Port Configuration

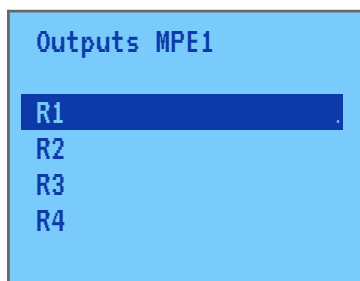

Relay port properties are similar to the valve properties. In the port list the letter **R** stands for a **relay** and the number is the **number of the relay (port)** on the corresponding extension.

For each **Relay port** the user can configure the **Master port**, the **Flowmeter** that shall be counting and monitoring the flow through this port. *Notice the flowmeter is configured separately in order to appear in this list.* The flow for the relay port can also be set manually in the interval 1 to 700 liters per minute.

```
Ext1 Relay1
Master:   R1.2
Meter:    M-EXT2.1
Flow,m3/h 12.0
```

IRRIOT supports **multiple levels of master ports**, i.e. a master port can have a master port, etc. The only limitation is that the chain of the linked ports **must not create circular dependencies**.

If the master port is configured for the Relay port it is displayed on the same line in format:

Rx.y, where **x** is the **number of the slot** of the extension that hosts the master Relay port and **y** is the **number of the relay port**

Or

WSx.y, where **x** is the **number of the Wireless Station** that hosts the master valve and **y** is the **number of the valve** on that Wireless Station.

Input Port Configuration

The extensions of **MPE6-4** type also have input configuration. Inputs are marked **IN1** to **IN6**. If configured the input type is also displayed as one of:

- AN** - analog (0..20mA or 4..20mA)
- CNT** - counter
- SW** - digital switch

```
Inputs MPE1
IN1.AN : 5.9
IN2 : -
IN3 : -
IN4 : -
IN5 : -
IN6 : -
```

IMPORTANT: there is a switch on the extension board that should be set for every configured input depending on whether the input is analog or digital.

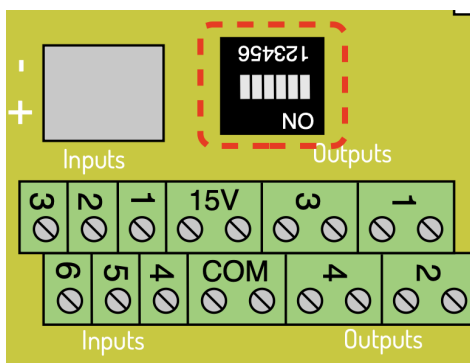

The corresponding position (denoted as **1,2,3,4,5 and 6**) of the switch should be set to **ON for analog** input and **OFF for digital** inputs (SW and CNT). Use the tip of a ball pen or toothpick to slide switches.

To configure the input first select one of the available types:

- *0...20mA*
- *4...20mA*
- *CNT*
- *SW*

0...20mA and 4...20mA Configuration

For analog input define the full range of the measured sensor. For example, for a pressure **gauge of 6 Bar**, set **Range to 6.0**.

```
EXT1 IN1
Type: 4...20mA
Range: 6.0
Use +/- to change
```

Another example: Water level gauge with **5m limit** configuration. If you want the level to be measured **in meters**, set **Range to 5**. If you want the level to be measured **in millimeters**, set Range to **5000**.

Switch sensor input Configuration

Digital switch has no additional configuration.

```
EXT1 IN1
Type: SW
Use +/- to change
```

Counter Input Configuration

For a counter type sensor the user should set the multiplier. The multiplier is one of the range:

0.001, 0.01, 0.1, 0.2, 0.3, 0.5, 1, 10, 100 and 1000

The default multiplier is 1.

How to select multiplier for most common sensors

Example 1: Rain Gauge 0.2 mm per pulse. To get the amount of fallen rain in mm the amount of pulses should be divided by 5. The multiplier $\frac{1}{5} = 0.2$ should be selected. 5 pulses give one mm. $5 \times 0.2 = 1\text{mm}$

Example 2: Flowmeter 10L per pulse. To get the volume in liters, use a multiplier of 10. However, more practical is to measure in cubic meters. To get the volume in m³: 100 pulses correspond to 1 m³. Thus the amount of pulses should be divided by 100 - multiplier should be $1/100 = 0.01$.

The parameter **Aggregate** determines how the measurement will be presented. The TOTAL aggregate is suitable for a flowmeter, while for a rain gauge the 24H (past 24 hours) is more relevant.

```
EXT1 IN1
Type: CNT
Multiple:1
Aggregat:TOTAL
Use +/- to change
```

Rules

Menu **Rules** allows the user to manage the **Irrigation Rules**. An irrigation rule is a **constraint that applies to the Run Times** it is assigned to. The same rule can be assigned to multiple Run times. The rule that you would normally want to apply to multiple Run Times is for example the Rain gauge based rule.

To enter **Rules** menu scroll down to **Rules** in main menu and hit OK:

```
MENU
Wireless Stations
Extensions
Rules
Status
Configuration
System OFF
```

```
Rules
Add Rule...
```

Create a new rule by selecting the **Add Rule...** or press **(+)**.

When creating a rule first **select one of the sensors** detected in the system. The sensors **B1** and **B2** are those **connected physically** to the Base Unit (not extension board) and are **always present**.

```
Rule 1

Sensor:B1
Mode: ACTIVE

Trigg: BREAK
```

```
Rule 2

Sensor:EXT1:1.CNT
Mode: ACTIVE

Trigg: OVER 0.0
Reset: NONE
```

Then, if configured, the **MPE6-4** extension connected sensors are listed. Extension connected sensor is presented in the following format: **EXTx.y.TYPE**, where **x** is the **slot** where this extension is detected, **y** is the **number of the input** (1 to 6), and the **TYPE** is the **type of the sensor** (AN,SW,CNT) as configured in the Extensions menu.

Finally, all the sensors connected in the field to the Wireless Stations (RTUs) are listed:

```
Rule 1

Sensor:WS1.Moist
Mode: ACTIVE

Trigg: OVER 15%
Reset: NONE
```

A rule can operate in one of these modes:

- **INACTIVE:** rules is never fulfilled;
- **ACTIVE:** normal mode. If triggered the rule causes the **RunTime** to transition to idle state (consume time, while valve is shut);
- **CORRECTIVE:** when fulfilled this rule transition the current **RunTime** to idle state and recalculates all remaining RunTimes using this Rule proportionally;
- **SUSPEND:** the rule causes the corresponding program to suspend, e.g. due to power outage. The time counting stops. At resume the program will be resumed when from the same moment it left.

A rule has **Trigger** and optionally **Reset** levels. The trigger is defined by a numerical level and **“greater than” (OVER)** or **“less than” (UNDER)** comparison statement. In the above example the rule is *fulfilled* when the level of the sensor reading is *greater than 15%*. Because the **rule represents a constraint** for a program Run Time, then Run Time it is connected to, is interrupted when the moisture rises over 15%.

If the **Reset** condition for a rule is not defined, the rule becomes *unfulfilled* when the **Trigger** condition is **no longer valid**, i.e. under 15%.

If the **Reset** condition is defined, the rule will continue to be *fulfilled* even after the **Trigger** condition is **no longer true**, until the **Reset** condition **becomes true**. In this example the Rule is *fulfilled* when soil moisture level is *above 50%*, and *unfulfilled* once the level drops *below 25%*.

```

Rule 1

Sensor:WS1.Moist
Mode: ACTIVE

Trigg: OVER    50%
Reset: UNDER  25%
    
```

```

Rule 2

Sensor:EXT1:1.CNT
Mode: ACTIVE

Trigg: OVER    12.0
Reset: NONE
    
```

Here is another example. It is a **Rain Gauge** based rule. The gauge is connected to the **extension board** of the **Base Unit** as a counter. The user creates a rule to terminate irrigation if the rain gauge indicates over *12 mm* precipitation over the past 24 hours.

When configuring the watering sequence in a program this **rule can be assigned to all the Run Times** that irrigate zones exposed to rain.

Configuration

Set Date/Time

It is important to have the time set correctly. Incorrect time may result in untimely execution of scheduled irrigation as well as cloud connection issues. The certificate for cloud connection is invalid if the time is off by more than 48 hours.

If the Base Unit is connected to the cloud, the time gets synchronized once a day. However to connect successfully to the Cloud in the first place, the time should be correct.

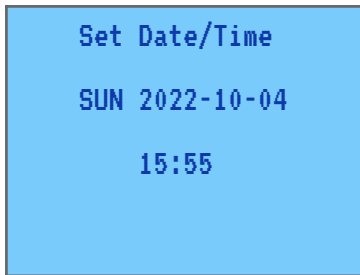

Use buttons \leftarrow , \rightarrow , \uparrow and \downarrow to navigate in the configuration menu. Use buttons **(+)** and **(-)** to select **Date** and **Time**. To complete press **OK**.

Advanced

This configuration menu contains just 2 parameters.

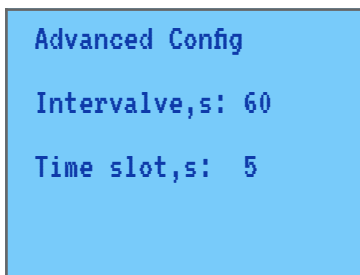

The **Interval** is the time in seconds between two consecutive valves in a program. This feature allows some time for the previously open valve to shut properly before opening the next valve in a program.

*Notice that the **Interval** time is not the additional inserted time, but decreases the configured **Run Time**. The default value of this parameter is 0 sec. The interval is between 0 and 300 sec.*

The **Time slot** is related to the interval between node communications. This parameter defaults to 5 sec, and in regular conditions should not be changed. Decreasing this value will decrease the latency of valve actuation commands, but it may seriously undermine signal conditions, creating congestion and as a consequence even longer delays. The allowed range is between 2 and 20 seconds.

Soft AP

The **Soft AP** is a WiFi access point temporarily created by the Base Unit in order to configure the permanent WiFi connection. The SSID of the created WiFi network is the same as the **Base Unit** name, printed on the label underneath the unit. This name is also found in the menu **About**.

After the **Base Unit** enters the **Soft AP** mode, it will not return to normal mode of operation. A reset of the unit will follow automatically, both on success and failure of connecting the permanent WiFi. To cancel the **Soft AP** mode, push the **Reset** button under the face cover, or simply wait for some 3-5 minutes.

Once the **Soft AP** is created, you should be able to see this WiFi on your device, e.g. on a mobile phone. The network is not password protected. Instructions on the screen will guide the user on the next actions.

Network Name	Signal	Security	
Wrmsby			Join
DIRECT-BC-HP ENVY Photo 6200			Join
Kapseln			Join
Hidden-36230325A2D4			Join
AudioPro_C10_BCB038			Join
LA			Join
DIRECT-9b-HP M377 LaserJet			Join
TN 24GHz 18C133			Join

Refresh

Use of WEP or Open networks is not secure and not recommended
 Choose OTHER to manually access a network.
 Choose DIRECT CONNECT to stay connected to this network.

WPS Push Button
 Press the WPS button
 on your
 Wi-Fi Access Point.
 Click

WPS Pin
 Enter the following
 WPS Enrollee
 PIN in your
 Wi-Fi Access Point.
 PIN: 0 Click

On submitting the web form with the permanent WiFi parameters, pay attention to the Base Unit's screen. It will display either a success or failure screen a few seconds prior to automatic reset.

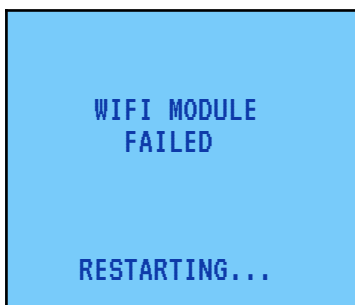

OR

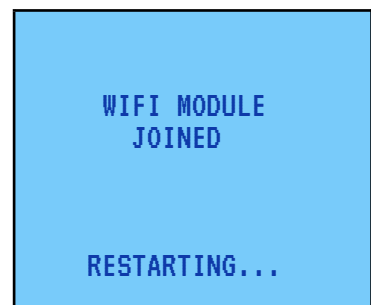

If connected successfully the **LED** on the **WiFi dongle** will lit green.

Reset WiFi

This command clears the permanent WiFi network data. The **LED** on the **WiFi dongle** will illuminate in orange.

Water Meters

See [Water Metering chapter in Basics of Operations](#) to understand the specifics of using water meters in IRRIOT.

Water Meters are connected to the **RTU** as a sensor. The RTU detects a water meter automatically. However the water meters require additional settings in order to operate. These settings are defined in **Configuration | Water Meters** menu.

```
Water Meters
M-WS1 75%<X<115%
M-WS10 75%<X<115%
Add Water Meter...
```

To configure a **Water Meter** scroll to **Water Meters** and press **OK**, select the water meter if you wish to configure or **Add Water Meter...** if need to register a new meter and press **OK**.

A **Water Meter** can also be added by pressing the **(+)** button while in the list of meters.

To remove a **Water Meter**, select it in the list and press the **(-)** button.

```
Water Meter Config
IN:EXT2.1 L/P:100
OF:150% UF: 50%
Span,m: 1
Head skip,m: 0
Leak Monitor: ON
```

In the **Water meter** configuration menu use buttons **←,→,↑** and **↓** to navigate. Use buttons **(+)** and **(-)** to select desired values.

To confirm, press the **OK** button. To leave without change press the **Back** button.

The **Station** is the number of physical **Remote Unit (RTU)** which this **Water Meter** is connected to. This value can be 1..32. You can assign this value when a new meter is added. In editing mode this value cannot be changed.

The **L/P** is the amount of liters per pulse. The values are 1, 10, 50, 100, 500 and 1000. The default is 10L.

Span is the averaging period for accumulation of pulses given in minutes. This parameter is applicable to RTU-connected flow meters only. The precision of the flow measurement for an RTU-connected flow meter will depend on a number of factors, e.g. on how frequently pulses come. If you see that the flow is not stable try to increase this value. The value up to *10 minutes* can be defined. The default value is *1 minute*. The higher the value the more stable the reading, but you have to wait longer for the measurement to complete.

The **Head skip** is the number of minutes the water meter shall wait before starting underflow and overflow monitoring. This allows to distinguish the overflow caused by damaged pipe from pressure build up. The value up to *15 minutes* can be defined. The default value is *0 minute*.

The UF (**Underflow**) is the percentage of the reference flow that is considered too low for normal operation. In case of detected underflow an alarm is raised.

The OF (**Overflow**) is the percentage of the reference flow that is considered too high for normal operation. In case of detected overflow an alarm is raised and the program is interrupted.

The **Leak Monitor** is the function that raises an alarm when the water flow is not stopped when all the connected valves are shut. The default for this function is *OFF*.

Other options

System OFF/ON

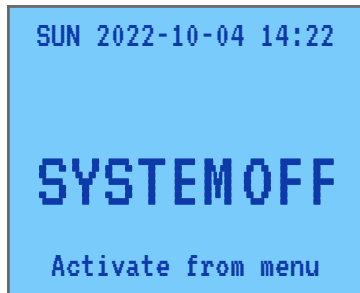

This option allows to **disable all scheduled and on-demand watering**. If any valve is open at the time the **System OFF** is executed, the valve(s) is ordered to shut as soon as possible. No other watering will take place until the system is set back in ON state.

Manual irrigation is possible even when the system is **in OFF state**.

Log

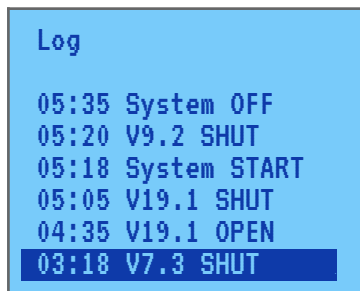

The **Log** stores the latest 200 events in the permanent memory. You can inspect the **Log** in order to verify past irrigations, sensor automation and so on.

About

```

About
BASE: 1.12.5
IrriotWiFi
WIFI: C6.3.4.8
F5:4E:32:65:07:C8
    
```

The About information menu displays basic settings for the **Base Unit**:

- Base Firmware version
- SSID of the permanent WiFi connection
- Version of WiFi Dongle
- MAC address

Appendixes

Appendix A: Alarms and Troubleshooting

Alarm	Reason	Troubleshooting	Reset (all alarms can be reset through Alarms menu)
OVERFLOW ¹	<p>The real-time flow through a valve on this Wireless Station (RTU) exceeds the overflow threshold set for the Water Meter.</p> <p>Often this alarm is caused by defective sprinkler or dislodged joint in pipeworks.</p> <p>The Base Unit automatically shuts the valve that caused overflow.</p>	<p>Repair/replace defective parts. If the overflow arises in normal conditions, the thresholds for the associated Water Meter may need to be adjusted towards more tolerance to deviations.</p>	<p>The alarm is reset when the flow has normalized. Alternatively a new Reference Flow can be ordered, which also resets this alarm.</p>
UNDERFLOW ²	<p>The real-time flow through a valve on this Wireless Station falls below the underflow threshold set for the Water Meter.</p> <p>Often this alarm is caused by clogging in the valves or pipes.</p>	<p>Clean the clogging. If the underflow arises in normal conditions, the thresholds for the associated Water Meter may need to be adjusted towards more tolerance to deviations.</p>	<p>The alarm is reset when the flow has normalized. Alternatively a new Reference Flow can be ordered, which also resets this alarm.</p>

¹ See chapter [Water Metering](#) for full documentation of this alarm.

² See chapter [Water Metering](#) for full documentation of this alarm.

<p>LEAKAGE</p>	<p>The meter observes some flow when all the associated valves are shut. The alarm is raised on the Remote (RTU) that controls the meter that detected the leakage.</p> <p>If the leakage is minor, the alarm may come and go. If the facility is not leak free, disable the monitoring.</p>	<p>Locate and repair the leakage point.</p> <p>Are all the valves, downstream the water meter, associated with this Water Meter? If there is some valve that the meter “does not know about”, set the meter in the valve’s settings.</p>	<p>The alarm is reset when the flow has stopped.</p>
<p>WSx BUSY</p>	<p>More than one program attempt to claim control over the same valve</p>	<p>Check your schedule. Make sure the programs that overlap never operate the same valve at the same time.</p>	<p>The alarm is ceased automatically upon the next successful control claim from a program.</p>
<p>WSx LOST</p>	<p>The contact with the Remote WSx has been lost. This alarm is raised if the Wireless station x has missed 10 or more communication windows. The time depends on the amount of Remotes in the facility.</p> <p>Often the WSx LOST alarm is preceded by a LOW BATTERY alarm for a number of days.</p>	<p>If the LOW BATTERY alarm is also active, the reason for alarm is battery depletion. Top up by exposing the Remote to direct sunlight or connecting a power bank or any other 5VDC source to the microUSB contact on the Remote. The charge level can be observed in the Base Unit Wireless Stations menu.</p> <p>If the battery is OK (over 50%) check the signal parameters. For benchmarks see the chapter Wireless Station General. If the signal is bad the RTU should be lifted (or used with an external antenna). Often, lifting the RTU just 0.5-1m would significantly improve the signal quality.</p>	<p>The alarm is reset when the WSx is re-discovered.</p>
<p>WSx SHORT Vy</p>	<p>The short circuited solenoid on the valve y of the Wireless station x. The alarm is raised upon an unsuccessful attempt</p>	<p>Check the wiring for short circuits.</p> <p>Measure the resistance of the</p>	<p>Restart of the RTU. See Wireless Stations chapter on how to restart RTU remotely.</p>

	to open or shut the valve.	solenoid. The value should not be below 4 Ohms. Replace the solenoid if faulty.	
WSx NO Vy	<p>Most often this alarm is the result of an opening attempt on the not connected valve. The Wireless stations report their physically connected valves when restarted. Detaching the valve while the Remote is running is not visible to the system until the actuation attempt.</p> <p>The cut off in the solenoid on the valve y of the wireless station x. The alarm is raised upon an unsuccessful attempt to open or shut the valve.</p>	<p>Make sure the valve is connected to the specified output of the Remote. Execute RTU restart to make the station report currently connected valves.</p> <p>Check the wiring for cut-offs.</p> <p>Measure the resistance of the solenoid. The value should not exceed 30 Ohms. Replace the solenoid if faulty.</p>	Restart of the RTU. See Wireless Stations chapter on how to restart RTU remotely.
ACTION TIMEOUT	<p>This alarm is raised when the Remote (RTU) fails to execute the command from the Base Unit during the stipulated time. The timeout is 3 regular communication windows. After this time, if the desired and reported state of the valves are not aligned, the Base Unit abandons further attempts and raises the alarm.</p> <p>Often the ACTION TIMEOUT alarm is the indication of bad communication between the Remote and the Base Unit.</p>	Improve signal conditions by elevating the RTU higher. Often 0.5-1m higher placement makes a big difference.	<p>The state of the Wireless Station should be changed to disabled to clear this alarm flag.</p> <p>Set the state back to enabled to resume alarm monitoring for the unit.</p>
LOW BATT	The battery state of charge is below 30%.	Clean the panel from dirt and snow. If necessary connect a power bank or any other 5VDC source to top up the charge.	The alarm is reset when the state of charge reaches 50%
WIFI LOST	The Base Unit has lost connection to the Cloud.	The Base Unit will do retries at increasing intervals (exponential	The alarm is reset when the Cloud connection is re-established.

		<p>back-off) until the period reaches approx <i>2 hours</i>. Then the retries will continue at the same interval until recovered.</p> <p>If you found the reason for the unavailable network connection, you may reset the Base Unit in order to speed up the recovery.</p> <p>If you use a mobile subscription make sure it is not dated.</p>	
WEAK WIFI	The signal strength of the WiFi signal is below <i>-85dBm</i> .	Provide more reliable WiFi connection.	The alarm is reset when the signal strength improves.
IoT Hub	IRRIOT Cloud connection failed	Typically this alarm arises when the WiFi is provided by a mobile router, and the mobile coverage in the area is not sufficient.	Use a more powerful cellular router, use external cellular antenna.
EXTENSION	One of the extension modules is not responding.	Check the ribbon cable connecting the extension to the Base Unit. If you have multiple extensions make sure they use different slot addresses.	Restart of the Base Unit clears this alarm.

Appendix B: Extension Boards

Extension board MPE6-4

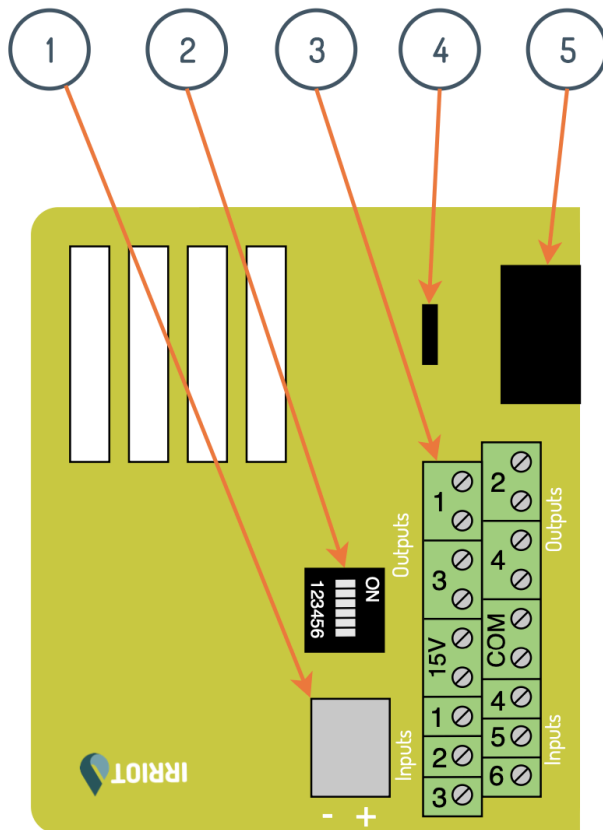

1. **12 VDC** Backup Battery port
2. **DIP** Switch
3. **Output and Input** ports
4. **Slot** selection Jumper
5. **Bus** Connector port

Technical Specifications:

Switching Voltage: **0 - 24VAC**
 Switching Current: **0 - 3A**
 Operating temperature range: **-20 to +60°C (-4 to 140°F)**

Optionally, up to 2 MPE6-4 (or RE-8) Extension Boards can be installed and connected directly to the **Controller (Base Unit)**. The board can be used to control various devices, which comply with Technical Specifications above, e.g. pumps, filters, fertilizer mixers, 24VAC valves with an *optional 24VAC transformer*, etc. **Please consult with an electrician on how to connect 24VAC valves with a transformer.**

In addition to the **4 relay outputs**, MPE6-4 extension features **6 sensor inputs**. The following sensor types are supported:

- 0-20mA current loop;
- 4-20mA current loop;
- Counter (e.g. flow meters or rain gauges);
- Switch type (e.g. rain sensor).

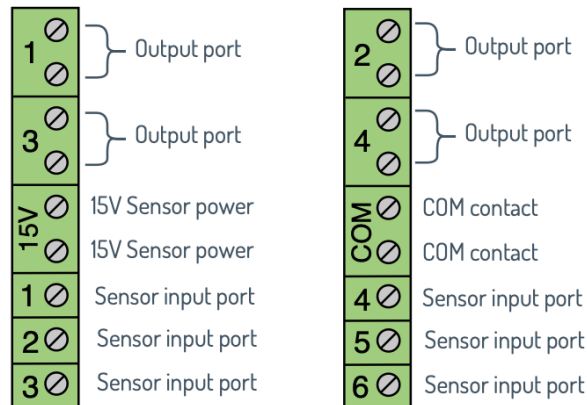

IRRIOT MPE6-4 Output Ports, 15V Sensor Power, COM contacts, Sensor Input ports

Current Loop Sensor Wiring

The wiring of the current loop sensor depends on whether it has the **3 or 2 wire** interface.

2 Wire: connect the red wire to one of the **15V** sensor power contacts, connect the black wire to one of the sensor input ports. Notice that the **DIP switch** for the corresponding input should be set to **ON position**:

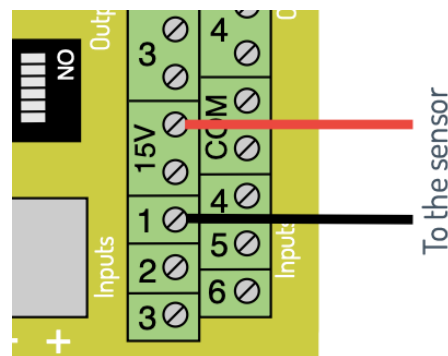

3 Wire: connect the red wire to one of the **15V** sensor power contacts, connect the black wire to one of the **COM** contacts, connect the sensor output wire to one of the input ports. Notice that the **DIP switch** for the corresponding input should be set to **ON position**:

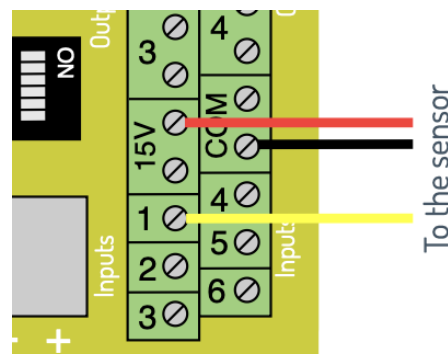

Counter and Switch Sensor Wiring

The **Counter** and **Switch** sensors are wired between one of the sensor input contacts and one of the COM contacts. Notice that the **DIP switch** for the corresponding input should be set to **OFF** position:

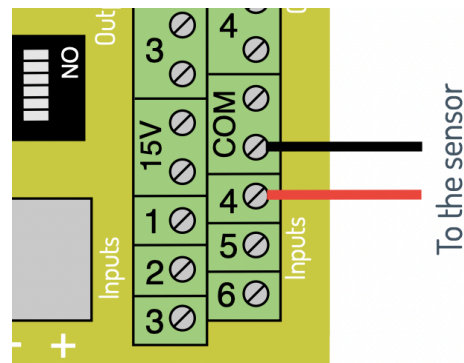

12VDC Battery port

The same board is used to provide a **12VDC** Car/Boat Battery or Solar Panel kit with Battery to power the Controller where AC power grid is not available. **Pay attention to the polarity, when connecting DC power.**

Bus connector

Bus connector port is used to connect the extension board to the controller (and optionally another extension board) with a ribbon cable provided.

Slot selection Jumper

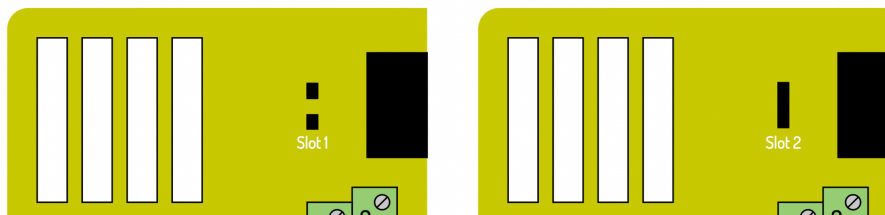

The Jumper switch is used to distinguish **Slot 1** and **Slot 2** used in the Controller, it's important when using 2 boards in one controller.

Jumper **Open** - **Slot 1**
 Jumper **Closed** - **Slot 2**

Attention!!! There should be **no high-voltage power** (above 24VAC) connected directly to the board as it may destroy the Extension Board and the Controller, thus void the warranty. If there's a need to use high-voltage, like 110-250VAC, then the extension board should operate an external relay or contactor rated for required power. All high-voltage or high-current jobs must be conducted only by a certified electrician. **The base controller must be powered down while connecting external devices.**

Extension board RE-8

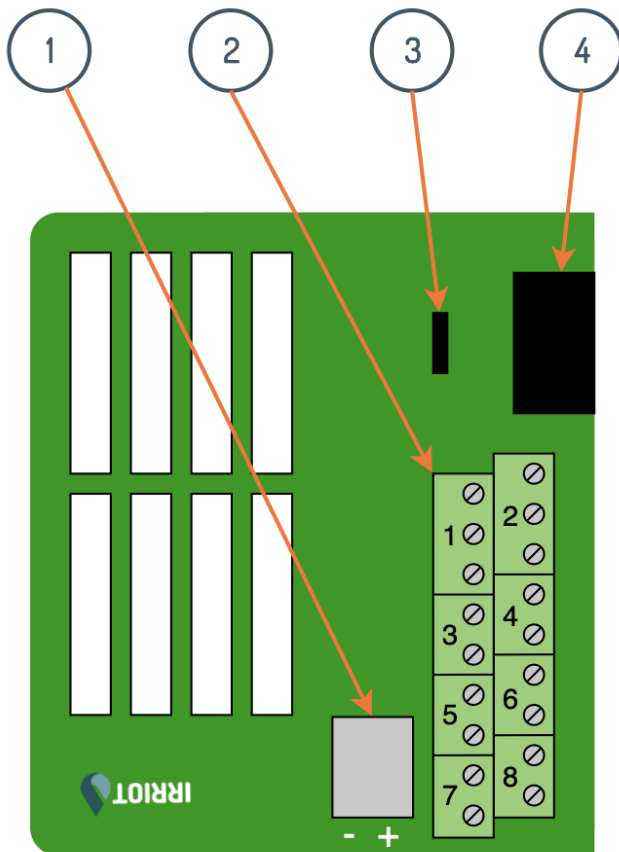

1. **12 VDC** Backup Battery port
2. **Output** ports
3. **Slot** selection Jumper
4. **Bus** Connector port

Technical Specifications:

Switching Voltage: *0 - 24VAC*
 Switching Current: *0 - 3A*
 Operating temperature range: *-20 to +60°C (-4 to 140°F)*

Optionally, up to 2 RE-8 Relay Extension Boards can be installed and connected directly to the **Controller (Base Unit)**. The board can be used to control various devices, which comply with Technical Specifications above, e.g. pumps, filters, fertilizer mixers, 24VAC valves with an *optional 24VAC transformer*, etc. *Please consult with an electrician on how to connect 24VAC valves with a transformer.*

12VDC Battery port

The same board is used to provide a **12VDC** Car/Boat Battery or Solar Panel kit with Battery to power the Controller where AC grid power is not available. **Pay attention to the polarity, when connecting DC power.**

Bus connector

Bus connector port is used to connect the extension board to the controller (and optionally another extension board) with a ribbon cable provided.

Output Ports

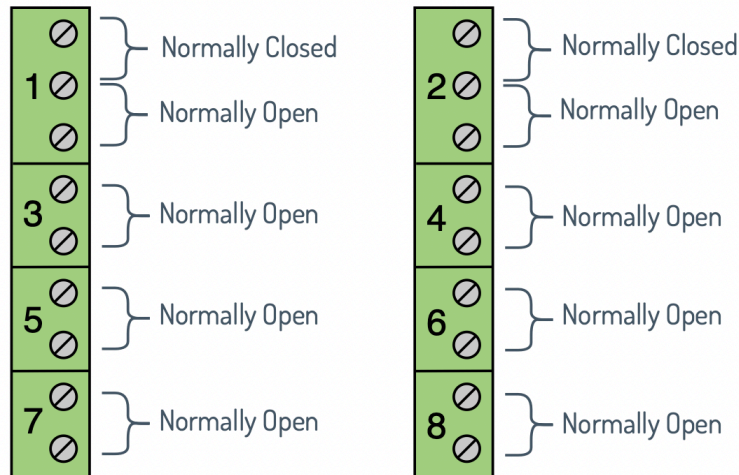

Note: Ports 1 and 2 have both default modes available - Normally Open and Normally Closed. Ports 3 - 8 Normally Open. Please see the picture above.

A **Normally Open** switch is a type of electrical switch. When a normally open switch is not compressed it remains **"off"**.

In a **Normally Open** switch, when the switch is off the contacts are open. This means the electrical connection is broken so the switch is **"off"**. In **Normally Closed** switches, the contacts are closed which connects the switch meaning that when they are not compressed they are switched **"on"**.

Slot selection Jumper

The Jumper switch is used to distinguish **Slot 1** and **Slot 2** used in the Controller, it's important when using 2 boards in one controller.

Jumper **Open** - Slot 1
 Jumper **Closed** - Slot 2

Attention!!! There should be **no high-voltage power** (above 24VAC) connected directly to the board as it may destroy the Extension Board and the Controller, thus void the warranty. If there's a need to use high-voltage, like 110-250VAC, then the extension board should operate an external relay or contactor rated for required power. All high-voltage or high-current jobs must be conducted only by a certified electrician. **The base controller must be powered down while connecting external devices.**

Appendix C: Winterization

IRRIOT system can be winterized in two ways:

- Remove deactivated RTUs (Wireless Stations) to a dry and warm place (recommended);
- Leave the RTUs (Wireless Stations) in the field in the winterized mode.

Notice that we recommend keeping the Controller (Base Unit) on during winter months. The software will be remotely upgraded with bug fixes and new features by the IRRIOT tech support team.

Notice that winterization of the watering infrastructure is not part of this document. Consult appropriate resources for advice.

Store RTUs Dry and Warm

To maximize the RTUs' lifetime it is recommended to remove them from the field during the freezing months.



Carefully disconnect the valve and, if applicable, also the sensor connection cables from the unit. Push the metal latch on the contact with your thumb while carefully pulling it out from the body. *Please see the picture.*

Failure to observe these rules may result in damage to the contact receptacle in the RTU.

During the periods when the sunlight decreases, the condition typically preceding freezing, some RTUs (Wireless Stations) may lose battery power. The current level of the charge can be seen in the Base Unit as well as in the mobile app. It is recommended to charge the RTUs (Wireless Stations) that are lower than 50% before putting them to storage. This will ensure maximum battery life. The storage optimized charge is 70-80%. Use a mobile charger (power bank), or any 5VDC power supply with microUSB contact.

Notice, the RTU will not charge when it is switched off!

To avoid unnecessary alarms in the system, set the RTU in the Disabled mode in the Base Unit or in the app. See [Wireless Station Configuration](#) chapter for details. Once in Disabled mode the removal of the Remote from the network will not cause Base Unit to raise "Contact Lost" alarm for the Remote.

After these steps, the Remote should be switched off:

Step 1. Unscrew the back lid

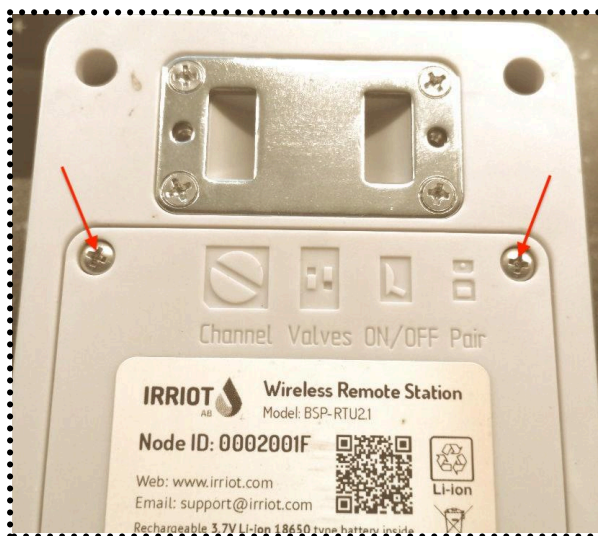

Step 2. Switch off the Power



Step 3. Screw back the cover and put the RTU away in the warm and dry place.

Leave the RTUs in the field in the winterized mode

An alternative way to winter store the RTUs is by leaving them in the diminishing sun, while setting them in **Winter mode**. In Winter mode the RTUs stop communicating with the Controller (Base Unit) in order to maximize the battery saving. See [Wireless Stations Configuration](#) for more info.

IRRIOT AB
P.O. Box 144
182 12 DANDERYD
SWEDEN
support@irriot.com